



Dimensions/Weight

Overall Dimensions (mm): 595(h) x 595(w) x 570(d)

Cutout Dimensions (mm): 598(h) x 598(w)

Weight: 29.3kg

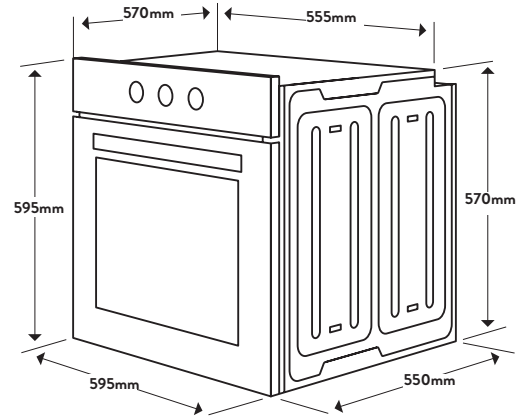

Technical Details

Style

Oven Type:	Standard
Category Size:	60cm
Capacity:	70 Litres

Functionality

Oven Functions:	Fan Forced Grill Grill with Fan Assist Defrost
Maximum Temperature:	270°C
Clock:	No
Timer:	Semi-Automatic
Number of Shelf Positions:	9
Interior Light:	Yes

Features & Accessories

Accessories:	2 x Chrome Wire Shelves 1 x Shallow Baking Tray
Easy View Door:	Yes

Installation

Maximum Current:	10amps Includes Plug
Connection:	240V, 50Hz
Installation Type:	Built-In

Made-In:	Europe
Warranty:	24 Months Parts & Labour

Aesthetics

Finish:	Black Glass with Stainless Steel Trim
Controls:	Knob Control
Door:	Top Opening, Double Glazed

Key Features



Easy View Door

With the extra large and clear window, monitoring your cooking has never been easier delivering the best results every time.



Plug & Play

Designed with a 10amp plug to connect straight into the wall means you plug in and go.



Serigraphy Under The Glass

With the markings under the glass it means that even after a heavy clean you will not rub off any key information. It is designed to stand the test of time.

Customer Care

T: 1300 739 033 (AU)

09 415 6000 (NZ)

E: customercare@omegaappliances.com.au

customercare@monacocorp.co.nz

Updated 30/01/2020 - V1

NB: Drawings are not to scale - they are to assist only.

WARNING: technical specifications and product sizes can be varied by the manufacturer without notice. Cutouts for appliances should only be by physical product measurements. The above information is indicative only.