

The logo for Omega, featuring the word "omega" in a bold, lowercase, sans-serif font. The letter "o" has a horizontal line underneath it, and the letter "a" has a horizontal line through its middle.

## Instruction Manual

### Rangehood

---

ORC93XA

ORC94XBA

# Thank you for purchasing an Omega appliance

Tailored for the modern aesthetic and lifestyle of busy people, your new Omega Appliance will make a welcome addition to the family.

Omega caters to style-savvy customers who look for balance between stunning form and clever function. This means a combination of sleek, chic, sophisticated design yet effortless functionality. And we source from the best. The best craftsmanship. The best innovation. From the best international design-houses.

All brought together under an appliance that stands for design-led balance.

Please take the time to read through the following instruction manual to familiarise yourself with the installation, operation requirements and maintenance to ensure optimum performance.

## Further Information

For important information about your Omega Appliance such as warranty registration, manuals, features, and specifications please visit [omegaappliances.com.au](http://omegaappliances.com.au) (if you are in Australia) and [omegaappliances.co.nz](http://omegaappliances.co.nz) (if you are in New Zealand) or contact our Customer Care team on the below email or phone numbers.

## Registering Your Warranty

For peace of mind you can register your warranty at [omegaappliances.com.au](http://omegaappliances.com.au). Further information on the Warranty can be found at the end of this manual.

## Contact Us

Our customer service team is here to help you with any question or concern. Both teams are on call Monday to Friday 8.30am to 5.00pm and of course you can always send an email at your convenience.

### Australia Contact Details

Monday to Friday 8.30am – 5.00pm  
Email: [customercare@omegaappliances.com.au](mailto:customercare@omegaappliances.com.au)  
Phone: 1300 739 033

### New Zealand Contact Details

Monday to Friday 8.30am – 5.00pm  
Email: [customercare@monacocorp.co.nz](mailto:customercare@monacocorp.co.nz)  
Phone: 09 415 6000

To stay up to date and find simple and easy recipes, follow us on our socials:

[facebook.com/omegaappliances](https://facebook.com/omegaappliances)  
[instagram.com/omegaappliances\\_au](https://instagram.com/omegaappliances_au)

## READ THE INSTRUCTION BOOKLET BEFORE INSTALLING AND USING THE APPLIANCE.

It is important that you retain these instructions, proof of purchase as well as other important documents about this product for future reference.

The manufacturer will not be responsible for any damage to property or to persons caused by incorrect installation or improper use of the appliance.

*Due to continual product development, Omega reserves the right to alter specifications and appearances without notice.*

## Contents

---

Important Safety Warnings .....	4
Specifications .....	5
Installation Instructions.....	6
Notice of Installation .....	7
Operating Instructions .....	8-9
Maintenance .....	10
Replacing the Lights .....	10
Australian & New Zealand Product Warranty Statements of Standard Warranty Conditions .....	11

## Disposal Information

---

- Most of the packaging materials are recyclable. Please dispose of these materials through your local recycling depot or by placing them into appropriate collection containers.
- If you wish to discard this product, please contact your local authorities and ask for the correct method of disposal.

## Important Safety Warnings

---

**IMPORTANT:** Read the assembly instruction section and safety precautions of this booklet carefully before removing the contents of this carton.

1. In certain circumstances electrical appliances may be a safety hazard.
2. This appliance is not intended for use by persons (including children) with reduced physical, sensory or mental capabilities, or lack of experience or knowledge, unless they have been given supervision or instruction concerning the use of the appliance by a person responsible for their safety. Young children should be supervised to ensure that they do not play with the appliance.
3. Do not check the status of the filters whilst the cooker hood is operating.
4. Do not touch the light bulbs after use.
5. Do not disconnect the appliance with wet hands.
6. Do not disconnect the power supply by pulling on the cable.
7. Do not flambé underneath the range hood.
8. Avoid free flame, as it may cause damage to the filters and can be a fire hazard.
9. Unplug the appliance before carrying out maintenance, cleaning or replacing lamps.
10. If the power cord is damaged, it must be replaced by the manufacturer, an authorised service centre or similarly qualified persons to avoid a hazard.
11. For indoor use only.
12. It is recommended to operate the range hood prior to cooking.
13. It is recommended to leave the range hood in operation for 15 minutes after cooking is terminated in order to completely eliminate cooking vapours and odours.
14. Turn off the range hood when not in use.
15. Do not use the range hood if it is damaged, especially the supply cord and the case.
16. Do not immerse the range hood in liquid.
17. The exhaust air must not be discharged into a flue which is used for exhausting fumes from an appliance burning gas or other fuels (not applicable to appliances that only discharge the air back into the room).
18. Regulations concerning the discharge of air have to be fulfilled.
19. There shall be adequate ventilation of the room when the range hood is used at the same time as appliances burning gas or other fuels (not applicable to appliances that only discharge the air back into the room).
20. Clean the surface of the cooker hood regularly using a cloth moistened with denatured alcohol or a non-abrasive liquid detergent.
21. There is a fire risk if cleaning is not carried out in accordance with the instructions.
22. The 600mm units are intended for use above hobs that are 600mm wide and the 900mm units are intended for use above hobs that are 900mm wide.
23. The range hood must be mounted at a minimum distance of 65cm above the cooking surface.
24. CAUTION: Accessible parts may become hot when used with cooking appliances.
25. Warning: Failure to install the screws or fixing device in accordance with these instructions may result in electrical hazards.

# Specifications

<b>Model</b>	ORC93XA
<b>Rated Input</b>	220V - 240V ~50Hz
<b>Rated Power</b>	268W
<b>Lighting Power</b>	2 x 1.5W LED
<b>Air tube diameter</b>	150MM
<b>Air output</b>	830m3/h Net

<b>Model</b>	ORC94XBA
<b>Rated Input</b>	220V - 240V ~50Hz
<b>Rated Power</b>	268W
<b>Lighting Power</b>	2 x 1.5W LED
<b>Air tube diameter</b>	150MM
<b>Air output</b>	830m3/h Net

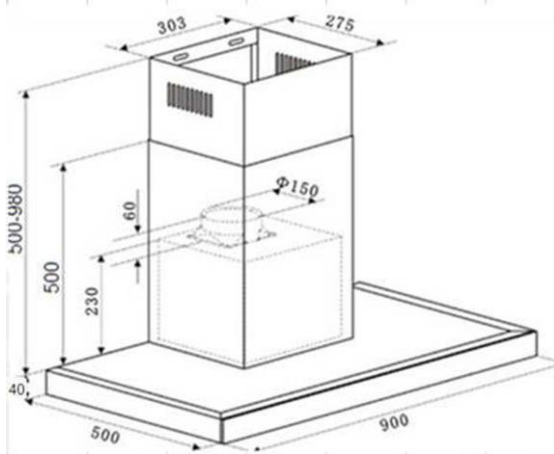

ORC93XA

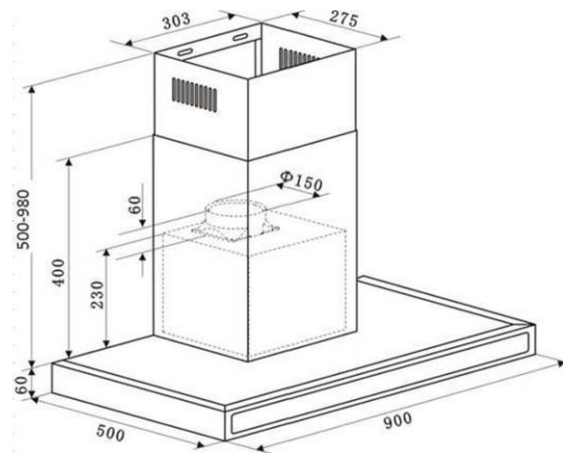

ORC94XBA

## Installation Instructions

The cooker hood should be placed at a distance of 65-75cm from the cooking surface for the best effect. See Pic 1.

Install the hook in a suitable place once the installation height is fixed, and keep it vertically aligned. The fixed position of the inside chimney bracket determines the location of the chimney.

Fix the outside chimney bracket on the outside chimney, and be sure that the inside chimney can be adjusted in height freely, as well as being able to fix the exhaust pipe (Not included in the rangehood). Afterwards, install the exhaust pipe and chimney on the cooker hood. See Pic 3.

Lift the cooker hood onto the hook. See Pic 4.

Adjust the height of the inside chimney to the position of the inside chimney bracket, and fix by screw. After adjusting the position, fix the body with safety screws. See Pic 5.

**Note:** The two safety screw holes are positioned on the back casing, with diameter of 6m.

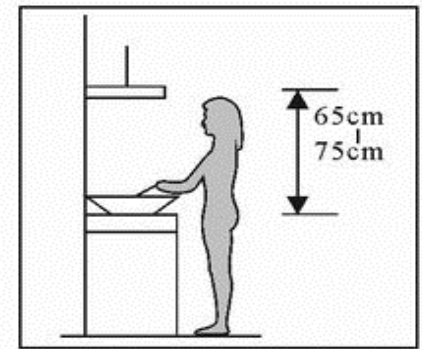

Pic1

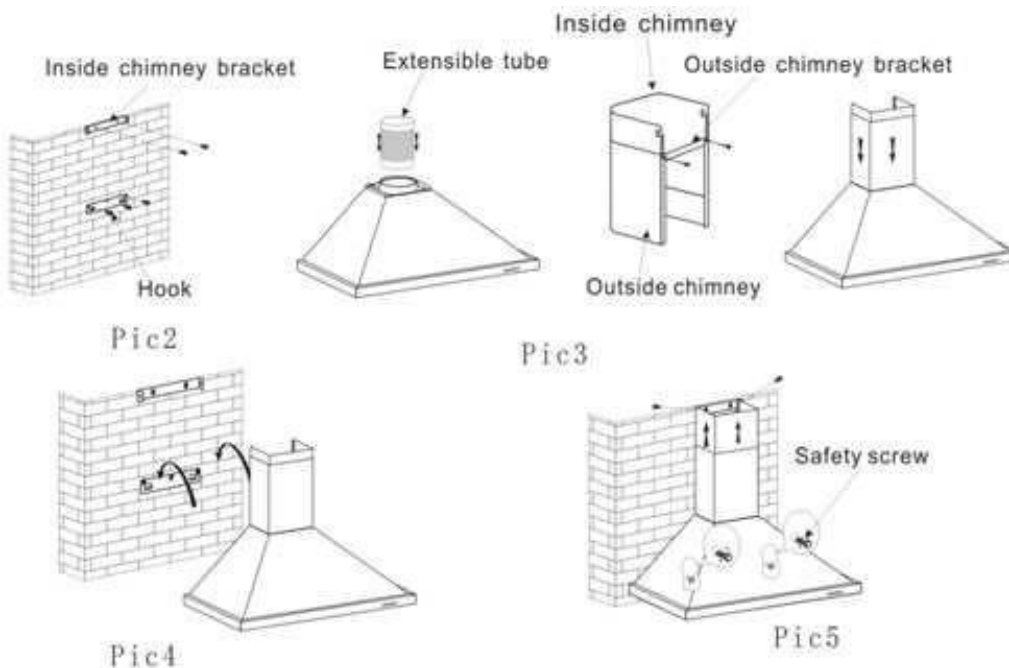

**Warning:** Failure to install the screws or fixing device in accordance with these instructions may result in electrical hazards.

## Notice of Installation

---

Before installation, please ensure the area is clean, to avoid suction of the remaining bits of broken wood and dust.

The canopy hood cannot share the same air ventilation ducting as other appliances, such as gas and electric heaters.

The bending of the ventilation ducting should be  $\geq 120^\circ$ , parallel or above the exit vent, and should be connected through the external wall.

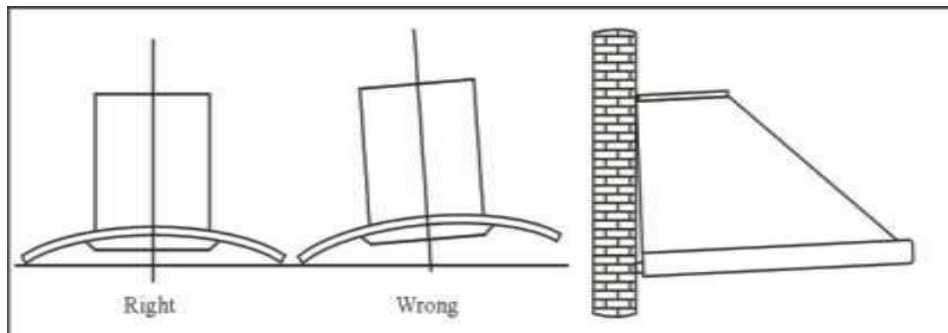

Pic5

After installation, make sure that the extractor is level to avoid grease collection at one end.

**NOTE:** Remove all protective plastic coatings from the stainless-steel surfaces before use.

## Operating Instructions

---

The re-usable aluminium grease filters supplied with this rangehood should be cleaned every month or so to avoid grease build-up.

To remove the grease filter, release the locking mechanism at the front of the filter, and lower the filter slightly to unhook it at the back.

Whilst the filter is removed, clean off any residual grease from the housing to avoid fire risk.

When replacing the grease filters, ensure that the locking mechanism is facing down.

### ORC93XA

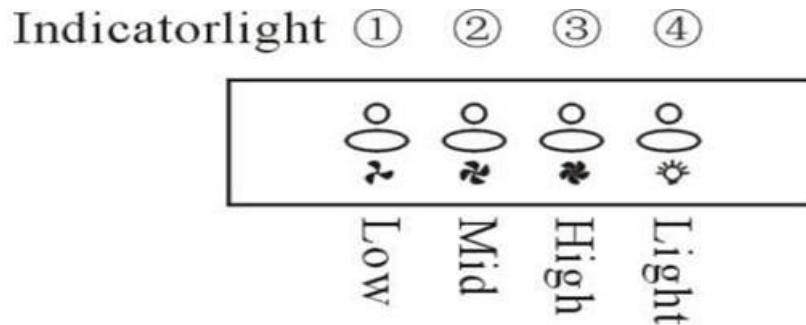

The range hood has indication diagrams to allow you to easily select the fan operating speed required.

Push the low button, indicated by a fan with 3 blades, and the motor will run at a low speed.

Push the medium button, indicated by a fan with 4 blades and the motor will run at a medium speed.

Push the high button, indicated by a fan with 5 blades and the motor will run at a high speed.

Push stop button, indicated by an (O) and the motor will stop. Push the light button, indicated by a lit globe and the two lights will come on. Push it again and the light will turn off.



# Operating Instructions

## ORC94XBA

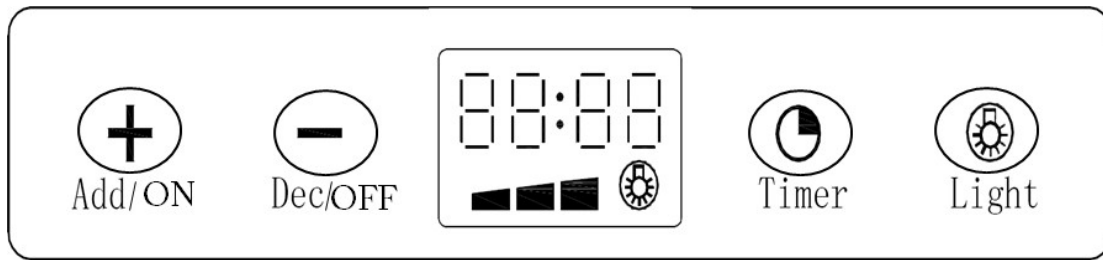

The ORC94XBA has a touch control panel.



When the power is connected and switched on you will hear a beep and the display screen will be backlit for 30 seconds and the rangehood will go into standby mode.

### SETTING THE TIME (24 hour time)

In standby mode hold down the Timer button  (2-3 seconds) until the Hour symbol on the display screen starts to flash.

Touch the Add/ON **+** or Dec/OFF (-) buttons to adjust the hour. Touch the Timer button  once the hours have been set this will allow you to adjust the minutes by touching the Add/ON **+** or Dec/OFF (-) buttons.

### ADJUSTING THE MOTOR SPEED

- Touch the Add/ON button **+** and the motor will run at low speed and the display screen will show .
- Touch the Add/ON button **+** again and the motor will run at medium speed and the display screen will show .
- Touch the Add/ON button **+** a third time and the motor will run at high speed and the display screen will show .

You are able to decrease the motor speed by touching the Dec/OFF button (-). Keep touching the Dec/OFF (-) button until all the bars disappear and the motor will stop and the rangehood will go into standby mode.



### LIGHT

The lights work independently of the other functions. Push the light button  and the two lighting lamps will come on the display screen will also show a light symbol. Push it again and the lamps will turn off.

### TIMER

The timer can be used to turn off the rangehood automatically after a period of time (5, 15 and 30 minutes).

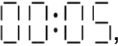
**Note:** The timer does not affect the lamps.

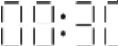
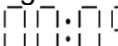
While the rangehood motor is running in any speed press the Timer button  and the display screen will show , press the Timer button again and the display will show , press the Timer button again and the display will show . If the Timer button is pressed again the display will go back to show .

# Maintenance

## Cleaning the Grease Filter Mesh

The filter mesh is made of high-density stainless steel. Please do not use corrosive detergent on it. Keeping this filter clean will keep the appliance running correctly. Please strictly follow the guidelines below.

- **Method 1:** Place the mesh in 40 – 50°C clean water, add in a small amount of detergent, and soak for 2 - 3 minutes. Wear gloves, and clean with a soft brush. Do not apply too much pressure, as the mesh is delicate and will damage easily.
- **Method 2:** The grease filters can be put into a dishwasher. To do so, set the temperature at around 60°C.

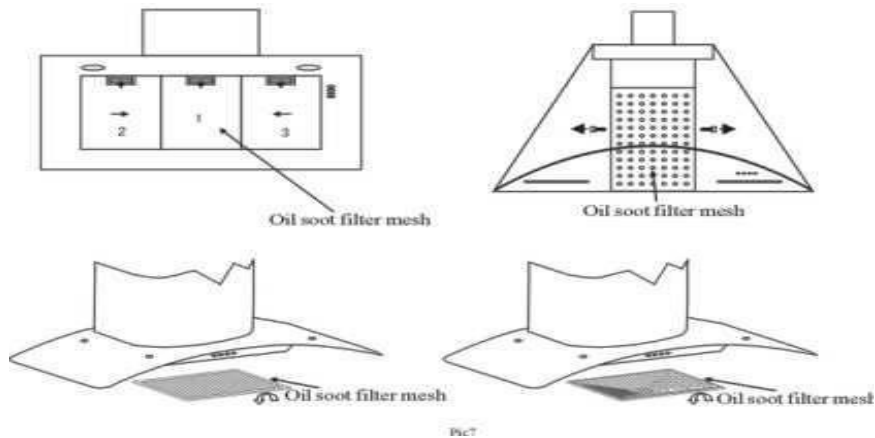

1. To protect the main body from corrosion over a long period of time, the cooker hood should be cleaned with hot water plus non-corrosive detergent every two months.
2. Please do not use abrasive detergent for it will damage the body.
3. Keep the motor and other spare parts free from water, as this will cause damage to the appliance.
4. Before cleaning the appliance please remember to turn off power
5. If fitted with active charcoal filters, the charcoal filter should not be exposed to heat.
6. Please do not tear open the fixed bar around the active charcoal filter.
7. If the supply cord is damaged, it must be replaced by the manufacturer or its service agent or a similarly qualified person in order to avoid a hazard.

## Replacing the Lights

Warning: Before attempting to replace the lights, ensure that the appliance is switched off and unplugged from the wall socket.

- Remove the grease filter.
- Press the spring on either side of the lamp until it drops out (Pic. 1).
- Gently pull out the connecting wire. Disconnect the terminals (Pic. 2).
- Replace the bulb with an identical one:
  - LED modules – round lamp.
  - Max Wattage: 2 x 1.5W
  - Voltage Range: 12V DC
  - ILCOS D Code: DSR-1.5/65-S-64
- Replace the grease filter.

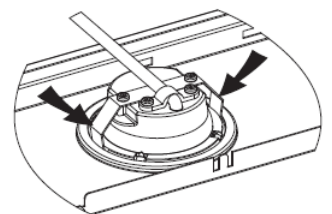

Pic 1

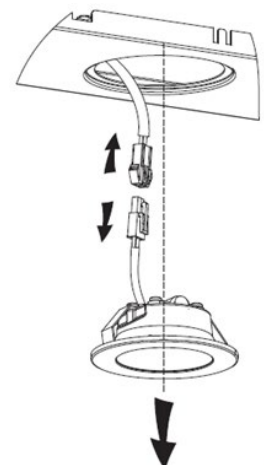

Pic 2

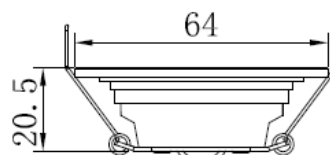

**omega**

# Australian & New Zealand Product Warranty Statements of Standard Warranty Conditions

## Australian Customers

Our goods come with guarantees that cannot be excluded under the Australian Consumer Law. You are entitled to a replacement or refund for a major failure and for compensation for any other reasonably foreseeable loss or damage. You are also entitled to have the goods repaired or replaced if the goods fail to be of acceptable quality and the failure does not amount to a major failure.

## New Zealand Customers

Nothing herein contained shall be construed in any way as excluding or limiting your rights under the Consumer Guarantee Act 1993.

## Our Warranty

This product is also covered by the manufacturer's warranty set out in this document (Our Warranty).

Our Warranty is for a period of twenty four (24) months from the date of purchase and for refrigeration appliances will have an additional thirty six (36) months after the first twenty four (24) months on the Sealed System (PARTS only) Compressor & condenser etc. The labour cost to replace these parts is the responsibility of the customer. This is in addition to (and does not exclude, restrict or modify) any rights or remedies to which you may already be entitled under the Australian Consumer Law or the New Zealand Consumer Guarantee Act 1993 relating to this product. Our Warranty (which is subject to the conditions below) covers rectification free of charge of any fault arising from defective materials or components, or faulty workmanship. The product will be repaired or replaced at the option of Omega, and all costs of installation, removal, cartage, freight travelling expenses and insurance are to be paid by the customer.

Our Warranty is subject to the following conditions:

1. That the purchaser contact Omega prior to any product repair.
2. That the purchaser carefully follows all instructions provided with the product and complies with all relevant electrical & plumbing regulations in their State when installing the product.
3. That the purchaser carefully follows the instructions provided in the owner's handbook relating to the proper use and care of the product and does not use the product for any purpose other than the DOMESTIC use for which it has been designed. If the appliance is used in commercial applications or for rental purposes, Our Warranty is limited to a warranty of Twelve (12) months covering all parts with Three (3) months on any labour cost of service or repair.

## Service Area

The provision of service under Our Warranty is limited by the boundary / territory area of the nearest service centre. Travelling cost incurred for service outside this area is not covered by Our Warranty

and service will incur commercial cost to be paid by the customer regulated by the number of kilometres travelled beyond the service area. These costs will be disclosed to you for acceptance by you prior to your claim being processed. Microwave ovens must be returned to your nearest Authorised Service Centre for repair as they are a carry in serviceable appliance.

## What is Covered by our Warranty

During the warranty period, Omega or its authorised Service Centre will, at no extra charge, if your appliance is readily accessible without the need of special equipment and subject to the terms and conditions of this warranty, repair or replace any parts which it considers defective.

## What is not Covered by our Warranty

1. Products installed damaged or incomplete or not in compliance with the relevant electrical & plumbing regulations in their State.
2. Normal wear and tear e.g. cleaning, light globes, filters etc.
3. Failure resulting from power surges and electrical storms.
4. Insect or vermin infestation.
5. Unauthorised repairs or use of non-genuine Omega parts.
6. Any failure caused by the product not being used in accordance with the instruction and the installation manual provided with the product.
7. Misuse or abuse, including failure to properly maintain or service.
8. The clearing of blockages in pumps and hoses.
9. Damage which occurs during delivery or installation.
10. Claims to product surface coating due to liquid or solid spill-overs, accidental damage or damage caused from cleaning products not recommended by Omega.

## How to Claim Our Warranty

While registering your warranty is not a requirement, for peace of mind you can register your warranty at [omegappliances.com.au](http://omegappliances.com.au).

To make a claim under Warranty you will need to contact Omega in Australia or New Zealand by using the contact details below.

If you are contacting Omega regarding any warranty claims and spare parts inquiries, please make sure you have the following information on hand:

1. Product Name/Model Number
2. Serial Number/s
3. Purchase Date (as per invoice or proof of purchase)
4. Purchased From
5. Warranty Registration Number (if registered)

## Contact Us Australia

Omega is a division of Shriro Australia Pty Ltd  
Phone: 1300 739 033  
Email: [customercare@omegappliances.com.au](mailto:customercare@omegappliances.com.au)

## Contact Us New Zealand

Omega is a division of Monaco Corporation (member of Shriro)  
Phone: 09 415 6000  
Email: [customercare@monacocorp.co.nz](mailto:customercare@monacocorp.co.nz)

