

omega

INSTALLATION, OPERATION
AND MAINTENANCE INSTRUCTIONS

Induction Cooktop

OI63Z

CONGRATULATIONS

Welcome to the Omega Community and thank you for choosing one of our many fantastic cooking appliances. We are confident that you will now be able to meet your cooking needs. Before you use the cooktop we strongly recommend that you read through the whole user manual which provides the description of this product and the proper use of its functions.

To avoid the ever-present risks involved with using an electrical appliance it is vital that the appliance is installed correctly by an authorised person and that you read the safety instructions carefully to avoid misuse and hazards.

It is important that you retain these instructions and your proof of purchase along with any other important documents about this product for future reference. Due to continual product development, Omega reserves the right to alter specifications or appearances without notice.

CONTENTS

SECTION PAGE NO.

Important Safety Instructions	3
Appliance Details	4
Electrical Connections	5
Installation	6-7
Operating Instructions	8-10
Cleaning	11

IMPORTANT SAFETY INSTRUCTIONS

IMPORTANT: Read the assembly instruction section and safety precautions of this booklet carefully before removing the contents of this carton.

1. This appliance is not intended for use by persons (including children) with reduced physical, sensory or mental capabilities, or lack of experience or knowledge, unless they have been given supervision or instruction concerning the use of the appliance by a person responsible for their safety. Children should be supervised to ensure that they do not play with the appliance.
2. After removing the packaging, make sure to check if there is any damage to the appliance. If there is any damage, never attempt to use the appliance and immediately contact your Authorised Service Centre. As packaging materials can be dangerous to children, they need to be collected immediately and put out of reach.
3. In certain circumstances electrical appliances may be a danger hazard. Check the conformity of voltage and power settings, which are specified on the information plate attached to the appliance and/or packaging, with the usage conditions available.
4. Do not place heavy objects in or on these appliances, use for storage or as a cutting surface as sharp edges can damage the surface. This appliance is designed for cooking food only. Use flat based, stable, inductive cooking rated cooking vessels only.
5. This appliance is designed for domestic household use only and for the cooking of domestic food products. Use as a commercial appliance will void the warranty. It should not be used in a marine environment or outdoors and must be fully built in. Do not use the appliances until fully installed.
6. A means for disconnection must be incorporated in the fixed wiring in accordance with the wiring rules.
7. The electrical connection must be accessible after installation. The appliance must be electrically isolated before any maintenance can be performed.
8. The appliance is not intended to be operated by means of an external timer or separate remote control system.
9. Electrical connection must be made as per local wiring rules and regulations. Do not disconnect the appliance with wet hands or bare feet, and do not disconnect the power cord with extreme force.
10. Ensure that the kitchen is well ventilated or mechanical ventilation is in use while cooking on this appliance.
11. Do not store or use flammable materials or aerosols near the cooktop. Items made from aluminium, plastic, plastic film & sugar based foods should also be kept away from the appliance, as they may fuse to the surface.
12. WARNING – The surface temperature of this appliance exceeds 95°C. To avoid a hazard, under bench access must be restricted. A board must be installed underneath the cooktop. Heat from the underside of the unit will be expelled by inbuilt fans – do not block.
13. WARNING - The cooktop will become hot during and directly after use. Do not touch the surface during this time, as it may be hot and can cause burns. To avoid burns, children should be kept away.
14. Cleaning may only be commenced on the appliance once it has cooled down and is turned off. Failure to clean properly can damage the unit. Do not use a steam jet or any other high pressure cleaning equipment to clean the appliance.
15. When the appliance is not being used, turn the appliance off.
16. Where this appliance is installed in a caravan, it shall NOT be used as a space heater.
17. Do not modify this appliance.
18. Do not use harsh abrasive cleaners or sharp metal scrapers to clean the glass surface as they can scratch the surface, which may result in the glass shattering. Clean the glass using a warm damp cloth (e.g. dishcloth) and dry it with a soft dry tea towel.
19. All cabinetry and materials used in the installation must be able to withstand a minimum temperature of 80°C whilst in use. Certain types of vinyl or laminate kitchen furniture are particularly prone to heat damage or discolouration at temperatures below the guidelines given above. Any damage caused by the appliance being installed without adhering to the temperature limits set out above will be the liability of the owner. To avoid any hazards, limit access to the under-bench section of the cooktop.
20. The appliance must be installed and put into operation by an authorised under the conditions provided by the manufacturer in this manual. The manufacturer cannot be held responsible for any damage that might occur due to faulty installation.
21. Damage can occur to bench tops if pots and pans are allowed to overlap the bench top. This can result in heat being transferred to the bench top. Ensure that correct sized pots & pans are used. Pans should be lifted on and off the cooktop surface and not dragged. Cooking zones should not be switched on without cookware placed on it. Do not place empty cookware onto the cooking zones when in use.
22. If any cracking is noticed on the cooktop, turn the appliance off immediately and call your Authorised Service Centre.
23. Do not leave the cooktop while cooking with solid or liquid oils. There may be flaming up in conditions of extreme heating. Never pour water onto the flames occurring from oil. Immediately turn the cooktop off and cover the pan with a lid or fire blanket in order to smother the flame.
24. Users with pacemakers should keep their upper body at least 30cm away from any operational inductive cooking zone. If in doubt, please consult your doctor before use.
25. Do not place metal objects such as spoons or pan lids onto the cooktop as they may become hot or cause damage to the surface.
26. A small amount of noise will sometimes be heard as elements turn on & off during operation. This is normal & not a fault.
27. Damage can occur to bench tops if pots and pans are allowed to overlap the bench top. This can result in heat being transferred to the bench top. Ensure that correct sized pots & pans are used. Pans should be lifted on and off the cooktop surface and not dragged. Cooking zones should not be switched on without cookware placed on it. Do not place empty cookware onto the cooking zones when in use.
28. Do not leave the cooktop unattended while cooking with solid or liquid oils. There may be flaming up in conditions of extreme heating. Never pour water onto the flames occurring from oil. Immediately turn the cooktop off and cover the pan with a lid or fire blanket in order to smother the flame.

APPLIANCE DETAILS

ELECTRICAL DETAILS:

COOKTOPS:

Rated Voltage: Single phase 220-240Vac 50Hz, 3-phase 380-415Vac 50Hz
6200W

COOKTOP – Directly wired to mains supply

This information can be found on the rating plate (identification plate) affixed to the underside of the appliance.

Type	Total Power
Induction	6200W

SIZES:

Relevant Sizes:	LENGTH (mm)	WIDTH (mm)	HEIGHT (mm)
Cooktop Size	590	520	53

Due to continual product development, Omega reserves the right to alter specifications or appearances without notice.
Dispose of packaging responsibly – recycle where facilities are available.

ELECTRICAL CONNECTIONS



LOCAL AUTHORITY REQUIREMENTS

Installation is only permitted by a licensed electrician, and carried out according to instructions provided by the manufacturer. Incorrect installation might cause harm and damage, for which the manufacturer accepts no responsibility.

ELECTRICAL INSTALLATION

Before carrying out the connection to the power supply, the voltage rating of the appliance (stamped on the appliance identification plate) must be checked for correspondence to the available mains supply voltage, and the mains electric wiring should be capable of handling the oven's power rating (also indicated on the identification plate). If you have any doubts, call in a qualified technician.

NOTE: For connections to the mains power supply, never use adapters, reductions or multiple power points as these may overheat and catch fire. Do not install separate timers.

After having installed the appliance, the switched outlet must always be in an accessible position.

The electrical safety of this appliance can only be guaranteed if the cooktop is correctly and efficiently earthed, always ensure that the earthing is efficient; if you have any doubts call in a licensed electrician to check the system. The manufacturer declines all responsibility for damage resulting from an installation which has not been correctly earthed.

WARNING: If any damage occurs to the power cable during or after installation, it must be replaced immediately by a licensed electrician with a replacement cable from your Service Centre.

The cooktops are to be connected to a single phase 220-240Vac 50 Hz supply (leaving the connections between points 1-3 in place) or 3 phase 380-415Vac 50Hz supply (removing the connections between points 1-3). They are earthed via the cable.

The mains terminal block is located on the underside of the cooktop and the terminals are accessible by removing the terminal block cover by removing the cover screw. Connect the appliance as shown in the diagram to the right.

The appliance is designed for fixed connection to the mains. During installation, an all pole disconnecter should be included inside the supply circuit with a contact opening of at least 3mm (rated 32A, delay functioning type). The power supply cord must not touch against any hot surfaces and must be placed so that its temperature does not exceed 75 °C at any point along its length.

IMPORTANT: The appliance must NOT be connected to the mains supply by means of a 10A or 15A plug and socket.

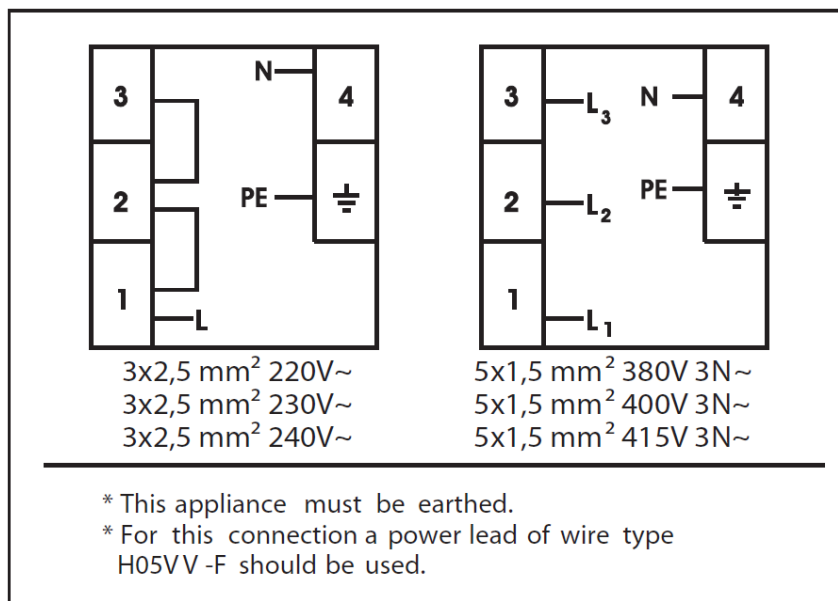

INSTALLATION



The adjacent furniture must be able to withstand a minimum temperature rise of 50°C above the ambient temperature of the room it is located in, during periods of use. The power supply to the appliance must be cut off before any adjustments or maintenance work is done on it.

PREPARATION FOR INSTALLATION AND USE

Manufactured with best quality parts and materials, this modern, functional and practical cooktop will meet your needs in all respects. Make sure to read the manual to obtain successful results so as not to experience any problems in the future. The information given below contains rules that are necessary for correct positioning and service operations. They should be read without fail, especially by the technician who will position the appliance.

CHOOSING A LOCATION FOR THE APPLIANCE

There are several points to pay attention to when choosing a location for your cooktop. Make sure to take into account our recommendations below in order to prevent any problems and dangerous situations, which might occur later!

When choosing a location for the cooktop, attention should be paid that there are no flammable or combustible materials in the close vicinity, such as curtains, oil, cloth etc. which quickly catch fire.

Furniture surrounding the cooktop must be made of materials resistant to temperatures above 50 C°.

Required changes to wall cabinets and exhaust fans above a built-in cooktop as well as minimum heights from the oven board are shown in Figure 1. Accordingly, the exhaust fan should be at a minimum height of 65 cm from the cooktop. If there is no exhaust fan the height should not be less than 70 cm.

□

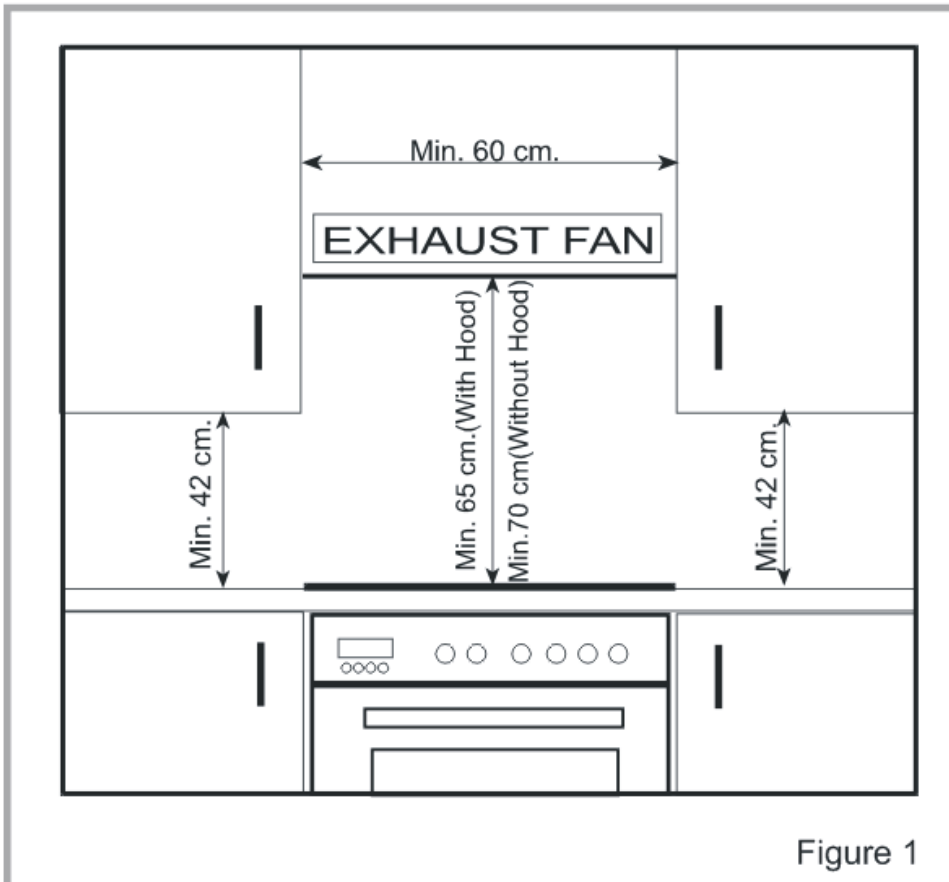

INSTALLATION OF BUILT IN COOKTOP

In order to prevent leakage of any liquids on the counter, a special sealing tape is supplied together with your cooktop. Apply this seal around the bottom edge of the cooktop (see below). The brackets are installed to hold the cooktop in place.

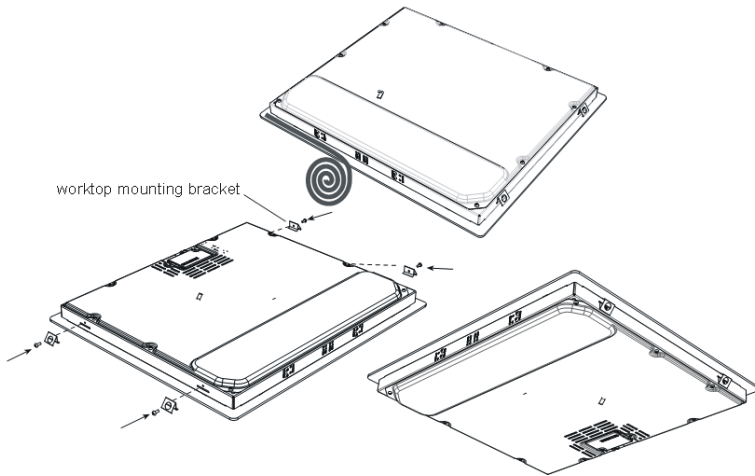

This appliance can be installed into a workbench 30-40mm thick. When cutting the hole in the work bench, keep in mind the correct space and ventilation which are shown in the diagrams below.

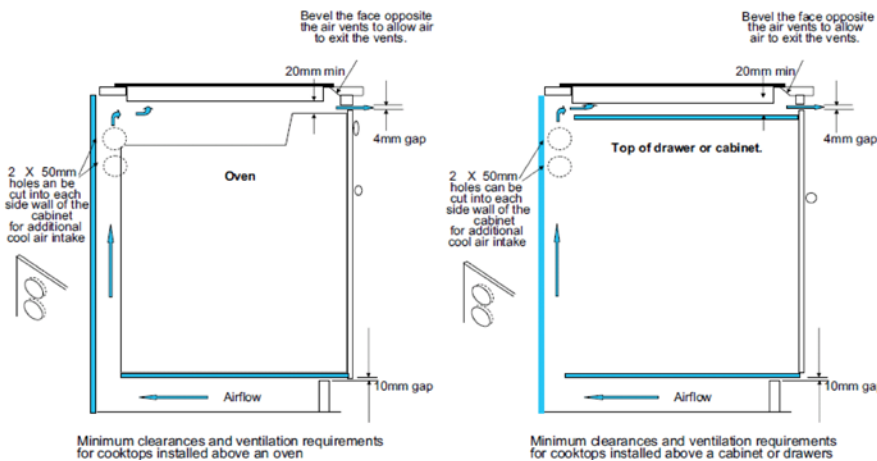

Cut out a hole in the bench top as shown below. Place the cooktop (controls to the front) in the hole and fix in position using the brackets

60cm induction hob

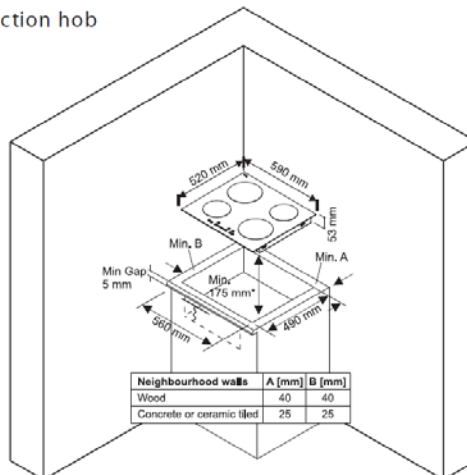

* : In the case of installation over built in oven, distance should be min. 10 mm.

The bottom of the cooktop reaches temperatures above 95°C. A board must be placed a minimum of 130mm below the cooktop that prevents anyone from touching the underside of the cooktop. Take care that there is adequate ventilation for air exchange to the inductive elements.

OPERATING INSTRUCTIONS

Cooking Surface

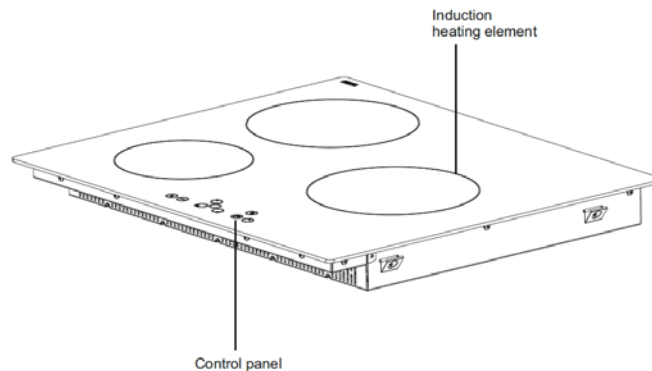

Control Panel

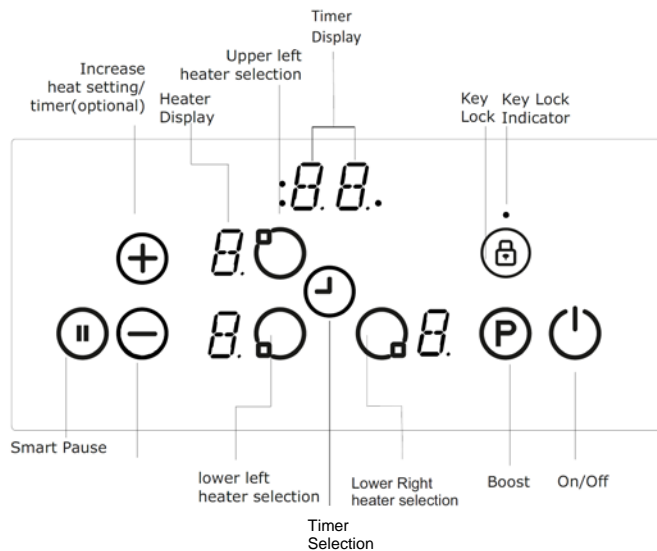

The induction cooktop appliance is operated by touching buttons, with the functions confirmed by LED displays and acoustic signals.

Turning On and Turning Off the Cooktop Appliance

NOTE: Do not operate the cooktop without first placing a suitably sized cooking vessel containing food on the appropriate cooking zone.

If the appliance is in Stand-By-Mode, it is put into Operating-Mode by pressing the On/Off button for at least 1 second. A beep signal indicates the successful operation acoustically.



On all Heat Level Displays a '0' will appear and all Decimal Points of the Heat Level displays will flash (1 second on, 1 second off).

If there is no operation within 20 seconds, all the Heat Level Displays will automatically turn off. If the displays are turned off, the hotplates will be re-set into Stand-By-Mode.

If the power button is pressed more than 2 seconds (in Operating-Mode), the appliance is switched off and is set into the Stand-By-Mode again. The appliance can be turned off by pressing the power button at any time; even if other buttons are pressed simultaneously.

If there is a residual heat of a hotplate remaining, this will be indicated in the correspondent heat setting Heat Level Display as a red "H".

Selecting A Cooking Zone

Select a single cooking zone by pressing the corresponding Heater Selection Button and the Decimal Point of the chosen cooking zone flashes. For the selected cooking zone, you can set or adjust the heat level between 1-9 by touching the Increase Heat Setting Button  (for the cooking zone in question) or Decrease Heat Setting Button . All of the other cooking zone displays will have a visible 'H' (if recently used) but they will not have a decimal point.

If left idle for more than 10 seconds, the decimal point on the chosen cooking zone display will turn off (the cooking zone is no longer selected). Press the Heater Selection Button again to select the cooking zone again. Other cooking zones can be selected without waiting for the previous one to become inactive.

The Heat Level Display works on a thermostat system. This means that the cooking zone will switch on and off in order to remain at the chosen Heat Level. NOTE the cooking zone will remain on for longer periods if a higher Heat Level is chosen, alternatively the cooking zone will be on less regularly on lower Heat Level Settings.

Turning Off Individual Cooking Zones

A particular cooking zone can be turned off in 2 different ways:

A) Simultaneously pressing the  and  buttons, after which a beep signal sounds and "0" appears in the Heat Level Display.

B) Reduction of the heat setting to "0" by operating the  button. When this happens, the associated Decimal Point of the cooking zone will also be turned off. If there is residual heat from this hotplate remaining, a red 'H' will be shown in the Heat Level Display area.

The Boost Function

The Boost function is available at each cooking zone. It is used to speed up the initial heat up time. Select a cooking zone and set the temperature. While the decimal point on the display is flashing, press the Boost

 button. The display will alternate between "P" and the heat setting.

Note: The Boost function is not always available (depending on what else is being used), and if the power requirements are exceeded, the display will flash with an alternative setting for 3 seconds.

Smart Pause

Smart Pause reduces the power of each cooking zone that has been activated. Press  on the desired zone

and it will reduce to level 1 and "II" will appear. Press  again to deactivate Smart Pause and "II" will disappear and the zones will return to the previous level.

If Smart Pause has not been deactivated, the cooktop will turn off after 30 minutes.



Safety Switch Off Function

Each cooking zone will switch off after a maximum operating time if the heat setting is not modified. The maximum operation time depends on the selected temperature level.

Heat setting	Safety switch off after
1 - 2	6 Hours
3 - 4	5 Hours
5	4 Hours
6 - 9	1,5 Hours

The Cooking Zone Timer Function

The timer function can be set for individual cooking zones. First select a cooking zone and set the heat setting.

While the decimal point is flashing, press the Timer Setting button . The timer display will show the current timer setting (flashing) for that cooking zone (00), with a separate indicator to the side representing the particular cooking zone. Press the Timer Setting/Increase Timer more times to increase the timer length (in minutes) or the Decrease Heat Setting Button/Timer Decrease button  to start from 60 minutes and decrease the timer length. The function is selected for 10 seconds at which time the main display stops flashing and starts

to count down to 0. The light representing the cooking zone stays lit until this point. While the timer is working, heat settings can be adjusted in the usual way, and the timer length adjusted as above. Note maximum time setting is 99.

Once finished, the timer display will flash "00" and the light representing the particular cooking zone will flash (with the cooking zone display flashing "O" or "H") with an audible alarm. This will continue for 30 seconds or until a button is pressed.

Multiple timers can be set for different cooking zones as above, with the timer display cooking zone indicator flashing to show which cooking zone is being adjusted at any time. In the case of multiple timers, after the 10 seconds, the shortest timer is always displayed. Once the alarm has run for 30 seconds (or a button is pressed) the next shortest timer is displayed.

The timer can also be used as a general timer. To do this, press the Timer Setting button  without selecting a cooking zone, and adjust the time period as is described above.

Pressing the Timer Setting button  a second time, or decreasing the time to 0 will turn off the timer functions.

Child Lock



The child lock is used to set the appliance up so when it is first turned on, it is in a locked mode (which must be unlocked before a cooking function can take place). While locked, touch modifications (e.g. increase heat settings) and others will not be possible. It is only possible to switch the appliance off.

Turn the appliance on, but do not activate any functions. Press the right hand front Increase Heat Setting Button



 and Decrease Heat Setting Button  together, and then the

right hand front Increase Heat Setting Button  again. The display shows an "L" on all cooking zone displays (or alternating "H" & "L") and will remain locked even if the unit is turned off & on.

While locked, cooking can be started by pressing the right hand front Increase Heat Setting

Button  and Decrease Heat Setting Button  together again. This action temporarily disables the lock so cooking can take place. Once cooking has finished & the unit turned off, the lock function restarts.

To unlock the unit, press the right hand front Increase Heat Setting Button  and Decrease Heat Setting

Button  together, and then the Decrease Heat Setting Button . The "L" displays will switch back to the heat settings and will not be active when the unit is next turned on.

Key Lock

The key lock is used to set the appliance up so that it cannot be adjusted while in use (only turned off), or cannot be turned on without disabling the lock.

To lock the appliance while operating, turn on the appliance and set all functions as above. Press the Key lock

button  for 3 seconds to activate the key lock (the Key lock active LED display will light up). From

this point, only the On/off Power Touch Control will operate. Unlock by pressing the Key lock button  for another 3 seconds.

To lock when not in operation, press the Key lock button  for 3 seconds and no functions operate. Unlock the same way as above.

CLEANING



NOTE: Cleaning and maintenance operations must only be carried out when the cooktop is cool (all residual heat indicators are off).

The appliance should be disconnected from the power outlet or turned off at your isolation switch before commencing any cleaning process.

Do not use plastic, plastic coated or aluminium cooking equipment on this appliance.

CLEANING THE COOKTOP

All cookware used on this appliance should be rated for induction cooking by the manufacturer. Cookware with rough bases should not be used as they can scratch the glass ceramic surface. The base of the good cookware should be as thick and flat as possible. Before use, make sure that cookware bases are clean and dry.

Always place the cookware on the cooking zone before it is switched on. If possible, always place the lids on the cookware. The base of any cookware used must not be smaller or larger than the cooking zones; they should be the proper size as indicated below, so as not to waste energy. If incorrectly placed, the U symbol will be displayed.

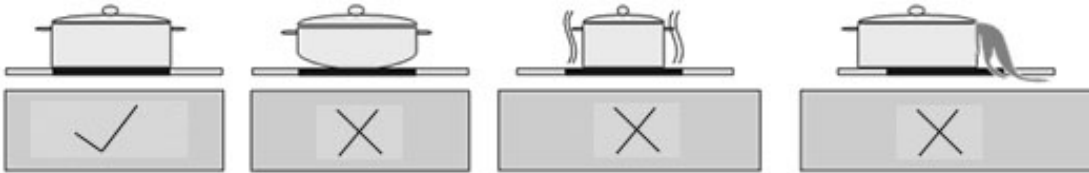

Before cleaning the cooktop, first isolate the cooktop from the power. Once done, ensure that there is no residual heat stored in the appliance. Vitroceramic glass is very resistant to high temperature and overheating. If there is residual heat stored in the appliance, the related residual heat indicator lamp will be on. In order to avoid burns, let the appliance cool down.

Remove all spilt food and fat with a clean damp, warm, slightly soapy, dishcloth. Rinse cloth and wipe cooktop again until clean, then wipe the cooktop dry with a clean tea towel or dry soft cloth.

If aluminium foil or plastic items are accidentally melted on the vitroceramic surface, they should be immediately removed from the hot cooking area with a scraper specifically for vitroceramic glass. This will avoid any possible damage to the surface. This also applies to sugar or food containing sugar that may be spilled on the cooktop. Enamelled steel, aluminium & copper will leave a residue on the surface that should be removed immediately or permanent damage may occur.

In the event of other food melted on the cooktop surface, remove the dirt when the appliance has cooled down. Use cleaner for glass ceramic or stainless steel when cleaning the surface.

Do not use abrasive sponges to clean the vitroceramic surface. These materials may damage the surface.

Do not use chemical detergents, sprays or spot removers on the vitroceramic surface. These materials may cause fire or the vitroceramic colour to fade. Clean with a damp, warm, slightly soapy, dishcloth.

WARNING: Using cookware that is too large can cause discolouration or damage to the cooktop surface around the heat zones, which is **NOT** covered under warranty.

A division of Shriro Australia Pty Ltd
104 Vanessa St Kingsgrove NSW 2208
IN AUSTRALIA: 1300 795 572
IN NEW ZEALAND: (09) 415 6000
www.omegapliances.com.au

IM Ref: OI63Z 12/2015/09FC

FOR INDOOR USE ONLY