



omega

Instruction Manual

Fixed Rangehood

ORF60XL

ORF90XL

Thank you for purchasing an Omega appliance

Tailored for the modern aesthetic and lifestyle of busy people, your new Omega Appliance will make a welcome addition to the family.

Omega caters to style-savvy customers who look for balance between stunning form and clever function. This means a combination of sleek, chic, sophisticated design yet effortless functionality. And we source from the best. The best craftsmanship. The best innovation. From the best international design-houses.

All brought together under an appliance that stands for design-led balance.

Please take the time to read through the following instruction manual to familiarise yourself with the installation, operation requirements and maintenance to ensure optimum performance.

Further Information

For important information about your Omega Appliance such as warranty registration, manuals, features, and specifications please visit omegaappliances.com.au (if you are in Australia) and omegaappliances.co.nz (if you are in New Zealand) or contact our Customer Care team on the below email or phone numbers.

Registering Your Warranty

For peace of mind you can register your warranty at omegaappliances.com.au. Further information on the Warranty can be found at the end of this manual.

Contact Us

Our customer service team is here to help you with any question or concern. Both teams are on call Monday to Friday 9.00am to 5.00pm and of course you can always send an email at your convenience.

Australia Contact Details

Monday to Friday 9.00am – 5.00pm
Email: support@residentiagroup.com.au
Phone: 1300 11 4357

New Zealand Contact Details

Monday to Friday 9.00am – 5.00pm
Email: customercare@monacocorp.co.nz
Phone: 09 415 6000

To stay up to date and find simple and easy recipes, follow us on our socials:

facebook.com/omegaappliances
instagram.com/omegaappliances_au

READ THE INSTRUCTION BOOKLET BEFORE INSTALLING AND USING THE APPLIANCE.

It is important that you retain these instructions, proof of purchase as well as other important documents about this product for future reference.

The manufacturer will not be responsible for any damage to property or to persons caused by incorrect installation or improper use of the appliance.

Due to continual product development, Omega reserves the right to alter specifications and appearances without notice.

Contents

Important Safety Warnings	4
Appliance Details.....	5
Installation Instructions.....	5-6
Operating Instructions	7
Cleaning.....	7
Replacing the Lamps	7
Troubleshooting	8
Warranty.....	9

Disposal Information

- Most of the packaging materials are recyclable. Please dispose of these materials through your local recycling depot or by placing them into appropriate collection containers.
- If you wish to discard this product, please contact your local authorities and ask for the correct method of disposal.

Important Safety Warnings

IMPORTANT: Read the assembly instruction section and safety precautions of this booklet carefully before removing the contents of this carton.

1. In certain circumstances electrical appliances may be a safety hazard.
2. This appliance is not intended for use by persons (including children) with reduced physical, sensory or mental capabilities, or lack of experience or knowledge, unless they have been given supervision or instruction concerning the use of the appliance by a person responsible for their safety. Young children should be supervised to ensure that they do not play with the appliance.
3. Do not check the status of the filters whilst the cooker hood is operating.
4. Do not touch the light bulbs after use.
5. Do not disconnect the appliance with wet hands.
6. Do not disconnect the power supply by pulling on the cable.
7. Do not flambé underneath the range hood.
8. Avoid free flame, as it may cause damage to the filters and can be a fire hazard.
9. Unplug the appliance before carrying out maintenance, cleaning or replacing lamps.
10. If the power cord is damaged, it must be replaced by the manufacturer, an authorised service centre or similarly qualified persons to avoid a hazard.
11. For indoor use only.
12. It is recommended to operate the range hood prior to cooking.
13. It is recommended to leave the range hood in operation for 15 minutes after cooking is terminated in order to completely eliminate cooking vapours and odours.
14. Turn off the range hood when not in use.
15. Do not use the range hood if it is damaged, especially the supply cord and the case.
16. Do not immerse the range hood in liquid.
17. The exhaust air must not be discharged into a flue which is used for exhausting fumes from an appliance burning gas or other fuels (not applicable to appliances that only discharge the air back into the room).
18. Regulations concerning the discharge of air have to be fulfilled.
19. There shall be adequate ventilation of the room when the range hood is used at the same time as appliances burning gas or other fuels (not applicable to appliances that only discharge the air back into the room).
20. Clean the surface of the cooker hood regularly using a cloth moistened with denatured alcohol or a non-abrasive liquid detergent.
21. There is a fire risk if cleaning is not carried out in accordance with the instructions.
22. The 600mm units are intended for use above hobs that are 600mm wide and the 900mm units are intended for use above hobs that are 900mm wide.
23. The range hood must be mounted at a minimum distance of 65cm above the cooking surface.
24. **CAUTION:** Accessible parts may become hot when used with cooking appliances.
25. Warning: Failure to install the screws or fixing device in accordance with these instructions may result in electrical hazards.

Appliance Details

	ORF60XL	ORF90XL
Rated Voltage	220 to 240V ~ 50Hz	220 to 240V ~ 50Hz
Rotation Method	Twin Motor, Twin Fan	Twin Motor, Twin Fan
Motor Input Power	100W + 100W	100W + 100W
Lamp (E14 olive)	1 x 2W LED	1 x 2W LED
Rated Input Power	202W	202W
Max Airflow	332m ³ /hr	345m ³ /hr
Outlet Diameter	120mm	120mm
Power Connection	10 Amp plug	10 Amp plug

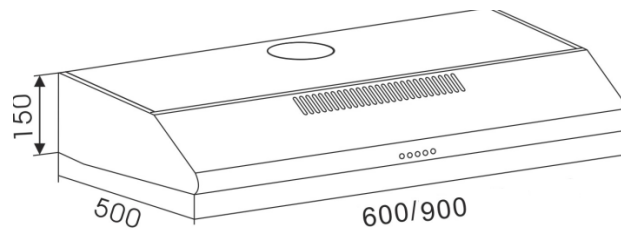

Installation Instructions

The range hood must be placed at a minimum distance of 65cm above the cooking surface. The maximum distance should be 75cm for the best effect.

Method one (Mounting to a wall):

1. To install onto the wall, drill 4 holes of \varnothing 8mm at a suitable place according with the centre distance of hole in the back of the cooker hood.
2. Insert the nut into the holes.
3. Insert the screws (ST4*30mm) into the nuts and tighten.
4. Put up the cooker hood onto the fixed screws.
5. Then use the attached accessories enclosed to turn the screws into the two holes of inside the hood, and then fix the screws to tighten the hood onto the wall.
6. Put the one-way valve onto the cooker hood.

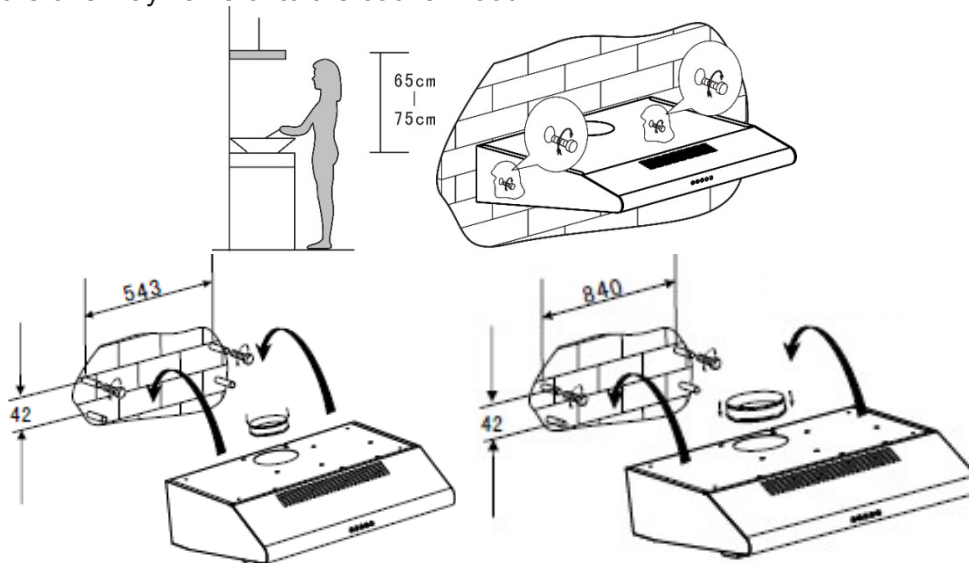

Installation Instructions

Method two (Mounting under a Cupboard):

1. Drill 4 holes of Ø 6mm at the bottom of the hanging cupboard.
2. Put the one-way valve on the cooker hood, then install the cooker hood on the bottom of the cupboard, tighten the hood with enclosed 4 screws (M4*35mm).
3. Install the adjusted board on the bottom of the hood in order to keep out the gap between hood back and cupboard.

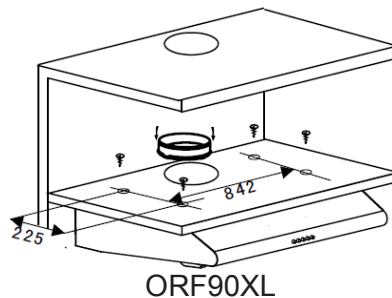
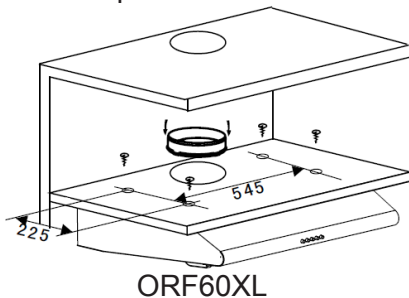

Venting Options:

There are two methods for ventilating the exhaust fumes; rear ventilation and top ventilation. Please pay attention to the ventilation method when installing.

Rear ventilation: As shown in pic. 4A, please use the cover to seal the outlet on the top, then the air can be vented from the back.

Top ventilation: As shown in pic 4B, please use the cover to seal the outlet on the back, then the air can be vented from the top.

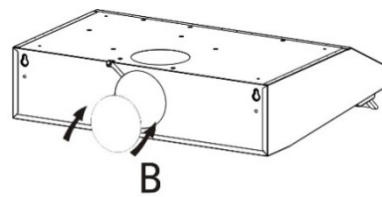
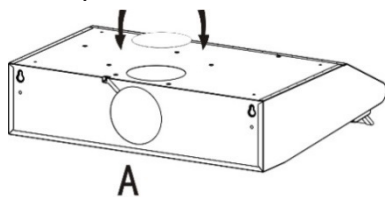

PIC4

Recirculating or Ducted Venting:

The rangehood can be installed to vent the exhaust fumes out of the room (ducted) or to recirculate the air back into the room once it has been filtered (recirculating).

To set the rangehood up to vent the exhaust fumes out of the room, adjust the venting switch (internal between the fans) forward and choose a venting system (rear or top). This is shown in Pics 5A & 5C.

To set the rangehood up to vent back into the room, block the rear and top outlets and adjust the venting switch to the rear. This will vent the exhaust fumes through the vents at the front of the rangehood. This is shown in PIC 5B & 5D. Note that carbon filters must also be fitted to the fan inlets as shown.

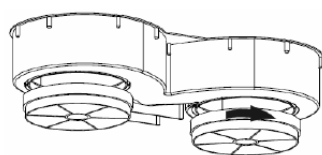
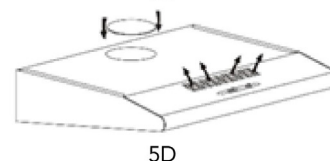
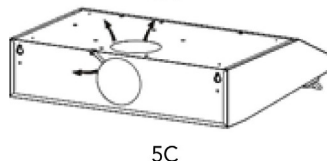
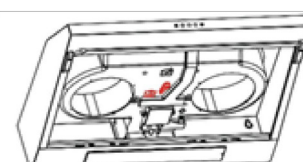
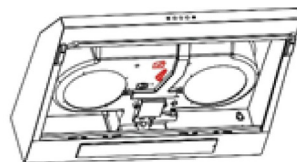

↑ Close

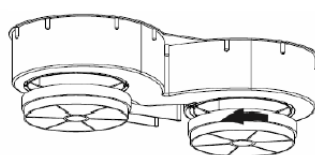

↓ Open

omega

Operating Instructions

The controls are at the front of the rangehood.

SPEED ADJUSTMENT:

1. Push 'Stop' button, and the motor will stop.
2. Push the 'Low' button, the buzzer will buzz once, and the motor runs at low speed.
3. Push the 'Mid' button, the buzzer will buzz once, and the motor runs at mid speed.
4. Push the 'High' button, the buzzer will buzz once, and the motor runs at high speed.
5. Push the 'Light' button and the two lights will come on. Push it again and the light will turn off.

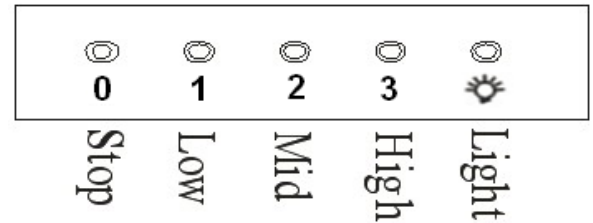

Cleaning

SAFETY PRECAUTION

Before cleaning your rangehood or performing any maintenance, please ensure that the range hood is turned off at the power point.

Do not use abrasive cleaners to clean the range hood. The use of warm soapy water and a cloth is recommended.

Ensure that the range hood is cleaned regularly, as a build-up of grease and fat may occur otherwise.

The filters on the range hood must be cleaned regularly to maintain efficiency, and prevent grease build up. The filter mesh is made of metal. It is recommended that this is undertaken every 4 – 6 weeks, depending on frequency of use. The filters can be cleaned with warm soapy water or a cloth.

Cleaning of the range hood must be performed as described above; otherwise there is a possibility of a fire hazard due to grease and fat build up.

Replacing the Lamps

1. Before changing the lights, make sure that the appliance is unplugged from the power source.
2. Open the filter.
3. Change the 2W LED lamp an identical bulb:
 - a. Max Wattage: 2W
 - b. Voltage Range: 220 – 240V AC
 - c. ILCOS D Code: DBS-2/65-H-120/33
4. Replace the filter to the original position.

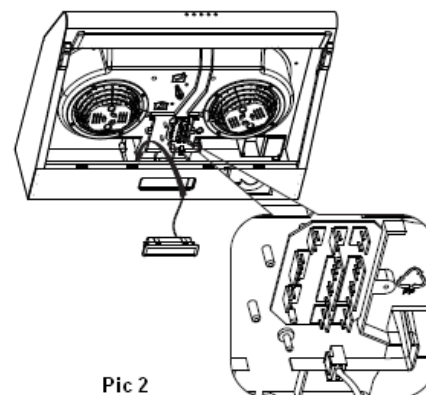
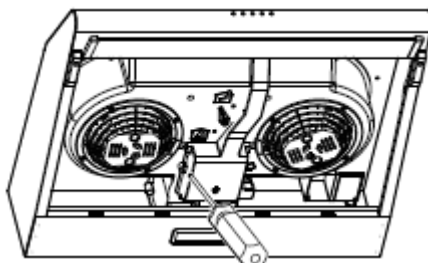

Troubleshooting

Fault	Possible Cause	Solution
Light on, but motor does not work	Fan switch turned off	Select a fan switch position.
	Fan switch failed	Contact Service Department.
	Motor failed	Contact Service Department.
Light does not work, motor does not work	House fuses blown	Reset/Replace fuses.
	Power cord loose or disconnected	Refit cord to power outlet. Switch power outlet on.
Oil leakage	One way valve and the air ventilation entrance are not tightly sealed	Take down the one way valve and seal with sealant.
	Leakage from the connection of U-shaped section and cover	Take U-shaped section down and seal.
Lights not working	Broken/Faulty globes	Contact Service Department.
Insufficient suction	The distance between the range hood and the gas top is too far	Refit the range hood to the correct distance.
The Range hood inclines	The fixing screw not tight enough	Tighten the hanging screw and make it horizontal.

Warranty

WARRANTY TERMS AND CONDITIONS RANGEHOODS

This document sets out the terms and conditions of the product warranties for Residentia Group Appliances. It is an important document. Please keep it with your proof of purchase documents in a safe place for future reference should you require service for your Appliance.

1. IN THIS WARRANTY

- (a) 'acceptable quality' as referred to in clause 10 of this warranty has the same meaning referred to in the ACL;
 - (b) 'ACL' means Trade Practices Amendment (Australian Consumer Law) Act (No.2) 2010;
 - (c) 'Appliance' means any Residentia Group product purchased by you accompanied by this document;
 - (d) 'ASR' means Residentia Group authorised service representative;
 - (e) 'Residentia Group' means Residentia Group Pty Ltd of 165 Barkly Ave, Burnley VIC 3121, ACN 600 546 656 in respect of Appliances purchased in Australia;
 - (f) 'major failure' as referred to in clause 10 of this warranty has the same meaning referred to in the ACL and includes a situation when an Appliance cannot be repaired or it is uneconomic for Residentia Group, at its discretion, to repair an Appliance during the Warranty Period;
 - (g) 'Warranty Period' means:
 - (i) where the Appliance is used for personal, domestic or household use (i.e. normal single family use) as set out in the instruction manual, the Appliance is warranted against manufacturing defects for 24 months, following the date of original purchase of the Appliance;
 - (h) 'you' means the purchaser of the Appliance not having purchased the Appliance for re-sale, and 'your' has a corresponding meaning.
2. This warranty only applies to Appliances purchased and used in Australia and is in addition to (and does not exclude, restrict, or modify in any way) any non-excludable statutory warranties in Australia.

3. During the Warranty Period Residentia Group or its ASR will, at no extra charge if your Appliance is readily accessible for service, without special equipment and subject to these terms and conditions, repair or replace any parts which it considers to be defective. Residentia Group or its ASR may use remanufactured parts to repair your Appliance. You agree that any replaced Appliances or parts become the property of Residentia Group. This warranty does not apply to light globes, batteries, filters, seals or similar perishable parts.
4. Parts and Appliances not supplied by Residentia Group are not covered by this warranty.
5. You will bear the cost of transportation, travel and delivery of the Appliance to and from Residentia Group or its ASR. If you reside outside of the service area, you will bear the cost of:
 - (a) travel of an authorised representative;
 - (b) transportation and delivery of the Appliance to and from Residentia Group or its ASR, in all instances, unless the Appliance is transported by Residentia Group or its ASR, the Appliance is transported at the owner's cost and risk while in transit to and from Residentia Group or its ASR.
6. Proof of purchase is required before you can make a claim under this warranty.
7. You may not make a claim under this warranty unless the defect claimed is due to faulty or defective parts or workmanship. Residentia Group is not liable in the following situations (which are not exhaustive):
 - (a) the Appliance is damaged by:
 - (i) accident
 - (ii) misuse or abuse, including failure to properly maintain or service
 - (iii) normal wear and tear
 - (iv) power surges, electrical storm damage or incorrect power supply
 - (v) incomplete or improper installation
 - (vi) incorrect, improper or inappropriate operation
 - (vii) insect or vermin infestation
 - (viii) failure to comply with any additional instructions supplied with the Appliance;

— THIS WARRANTY IS VALID IN AUSTRALIA ONLY —

Warranty

- (b) the Appliance is modified without authority from Residentia Group in writing;
 - (c) the Appliance's serial number or warranty seal has been removed or defaced;
 - (d) the Appliance was serviced or repaired by anyone other than Residentia Group, an authorised repairer or ASR.
8. This warranty, the contract to which it relates and the relationship between you and Residentia Group are governed by the law applicable where the Appliance was purchased.
9. To the extent permitted by law, Residentia Group excludes all warranties and liabilities (other than as contained in this document) including liability for any loss or damage whether direct or indirect arising from your purchase, use or non use of the Appliance.
10. For Appliances and services provided by Residentia Group in Australia, the Appliances come with a guarantee by Residentia Group that cannot be excluded under the Australian Consumer Law. You are entitled to a replacement or refund for a major failure and for compensation for any other reasonably foreseeable loss or damage. You are also entitled to have the Appliance repaired or replaced if the Appliance fails to be of acceptable quality and the failure does not amount to a major failure. The benefits to you given by this warranty are in addition to your other rights and remedies under a law in relation to the Appliances or services to which the warranty relates.
11. At all times during the Warranty Period, Residentia Group shall, at its discretion, determine whether repair, replacement or refund will apply if an Appliance has a valid warranty claim applicable to it.
12. Missing parts are not covered by warranty. Residentia Group reserves the right to assess each request for missing parts in a case by case basis. Any parts that are not reported missing in the first week after purchase will not provide free of charge.
13. To enquire about claiming under this warranty, please follow these steps:
- (a) carefully check the operating instructions, user manual and the terms of this warranty;
 - (b) have the model and serial number of the Appliance available;
 - (c) have the proof of purchase (e.g. an invoice) available;
 - (d) telephone the numbers shown below.
14. You accept that if you make a warranty claim, Residentia Group and its ASR may exchange information in relation to you to enable Residentia Group to meet its obligations under this warranty.

IMPORTANT

Before calling for service, please ensure that the steps in point 13 have been followed.

CONTACT SERVICE

→ Service: 1300 11 HELP (4357)

The Australian Consumer Law requires the inclusion of the following statement with this warranty:

Our goods come with guarantees that cannot be excluded under the Australian Consumer Law. You are entitled to a replacement or refund for a major failure and for compensation for any other reasonably foreseeable loss or damage. You are also entitled to have the goods repaired or replaced if the goods fail to be of acceptable quality and the failure does not amount to a major failure.

— THIS WARRANTY IS VALID IN AUSTRALIA ONLY —

