



omega

Instruction Manual

90cm Canopy Rangehood

ORC93XA

ORC94XBA

Thank you for purchasing an Omega appliance

Tailored for the modern aesthetic and lifestyle of busy people, your new Omega Appliance will make a welcome addition to the family.

Omega caters to style-savvy customers who look for balance between stunning form and clever function. This means a combination of sleek, chic, sophisticated design yet effortless functionality. And we source from the best. The best craftsmanship. The best innovation. From the best international design-houses.

All brought together under an appliance that stands for design-led balance.

Please take the time to read through the following instruction manual to familiarise yourself with the installation, operation requirements and maintenance to ensure optimum performance.

Further Information

For important information about your Omega Appliance such as warranty registration, manuals, features, and specifications please visit omegaappliances.com.au (if you are in Australia) and omegaappliances.co.nz (if you are in New Zealand) or contact our Customer Care team on the below email or phone numbers.

Registering Your Warranty

For peace of mind you can register your warranty at omegaappliances.com.au. Further information on the Warranty can be found at the end of this manual.

Contact Us

Our customer service team is here to help you with any question or concern. Both teams are on call Monday to Friday 9.00am to 5.00pm and of course you can always send an email at your convenience.

Australia Contact Details

Monday to Friday 9.00am – 5.00pm
Email: support@residentiagroup.com.au
Phone: 1300 11 4357

New Zealand Contact Details

Monday to Friday 9.00am – 5.00pm
Email: customercare@monacocorp.co.nz
Phone: 09 415 6000

To stay up to date and find simple and easy recipes, follow us on our socials:

facebook.com/omegaappliances
instagram.com/omegaappliances_au

READ THE INSTRUCTION BOOKLET BEFORE INSTALLING AND USING THE APPLIANCE.

It is important that you retain these instructions, proof of purchase as well as other important documents about this product for future reference.

The manufacturer will not be responsible for any damage to property or to persons caused by incorrect installation or improper use of the appliance.

Due to continual product development, Omega reserves the right to alter specifications and appearances without notice.

Contents

Important Safety Warnings	4
Specifications	5
Installation Instructions.....	6
Notice of Installation.....	7
Operating Instructions	8-9
Maintenance	10
Replacing the Lights	10
Warranty	11

Disposal Information

- Most of the packaging materials are recyclable. Please dispose of these materials through your local recycling depot or by placing them into appropriate collection containers.
- If you wish to discard this product, please contact your local authorities and ask for the correct method of disposal.

Important Safety Warnings

IMPORTANT: Read the assembly instruction section and safety precautions of this booklet carefully before removing the contents of this carton.

1. In certain circumstances electrical appliances may be a safety hazard.
2. This appliance is not intended for use by persons (including children) with reduced physical, sensory or mental capabilities, or lack of experience or knowledge, unless they have been given supervision or instruction concerning the use of the appliance by a person responsible for their safety. Young children should be supervised to ensure that they do not play with the appliance.
3. Do not check the status of the filters whilst the cooker hood is operating.
4. Do not touch the light bulbs after use.
5. Do not disconnect the appliance with wet hands.
6. Do not disconnect the power supply by pulling on the cable.
7. Do not flambé underneath the range hood.
8. Avoid free flame, as it may cause damage to the filters and can be a fire hazard.
9. Unplug the appliance before carrying out maintenance, cleaning or replacing lamps.
10. If the power cord is damaged, it must be replaced by the manufacturer, an authorised service centre or similarly qualified persons to avoid a hazard.
11. For indoor use only.
12. It is recommended to operate the range hood prior to cooking.
13. It is recommended to leave the range hood in operation for 15 minutes after cooking is terminated in order to completely eliminate cooking vapours and odours.
14. Turn off the range hood when not in use.
15. Do not use the range hood if it is damaged, especially the supply cord and the case.
16. Do not immerse the range hood in liquid.
17. The exhaust air must not be discharged into a flue which is used for exhausting fumes from an appliance burning gas or other fuels (not applicable to appliances that only discharge the air back into the room).
18. Regulations concerning the discharge of air have to be fulfilled.
19. There shall be adequate ventilation of the room when the range hood is used at the same time as appliances burning gas or other fuels (not applicable to appliances that only discharge the air back into the room).
20. Clean the surface of the cooker hood regularly using a cloth moistened with denatured alcohol or a non-abrasive liquid detergent.
21. There is a fire risk if cleaning is not carried out in accordance with the instructions.
22. The 600mm units are intended for use above hobs that are 600mm wide and the 900mm units are intended for use above hobs that are 900mm wide.
23. The range hood must be mounted at a minimum distance of 65cm above the cooking surface.
24. **CAUTION:** Accessible parts may become hot when used with cooking appliances.
25. **Warning:** Failure to install the screws or fixing device in accordance with these instructions may result in electrical hazards.

Specifications

Model	ORC93XA
Rated Input	220V - 240V ~50Hz
Rated Power	268W
Lighting Power	2 x 1.5W LED
Air tube diameter	150MM
Air output	830m3/h Net

Model	ORC94XBA
Rated Input	220V - 240V ~50Hz
Rated Power	268W
Lighting Power	2 x 1.5W LED
Air tube diameter	150MM
Air output	830m3/h Net

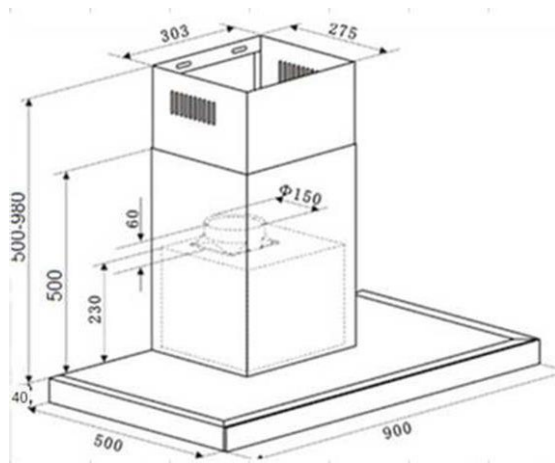

ORC93XA

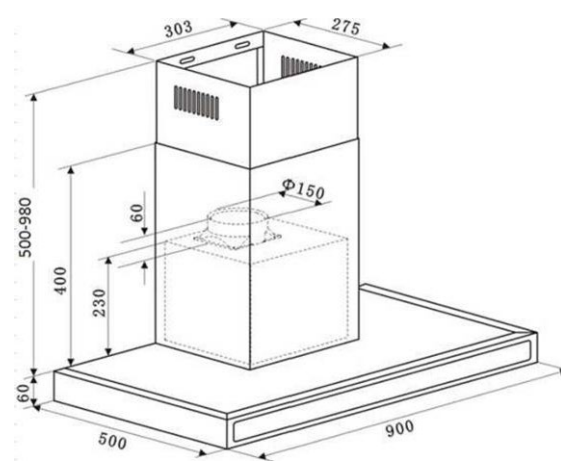

ORC94XBA

Installation Instructions

The cooker hood should be placed at a distance of 65-75cm from the cooking surface for the best effect. See Pic 1.

Install the hook in a suitable place once the installation height is fixed, and keep it vertically aligned. The fixed position of the inside chimney bracket determines the location of the chimney.

Fix the outside chimney bracket on the outside chimney, and be sure that the inside chimney can be adjusted in height freely, as well as being able to fix the exhaust pipe (Not included in the rangehood). Afterwards, install the exhaust pipe and chimney on the cooker hood. See Pic 3.

Lift the cooker hood onto the hook. See Pic 4.

Adjust the height of the inside chimney to the position of the inside chimney bracket, and fix by screw. After adjusting the position, fix the body with safety screws. See Pic 5.

Note: The two safety screw holes are positioned on the back casing, with diameter of 6m.

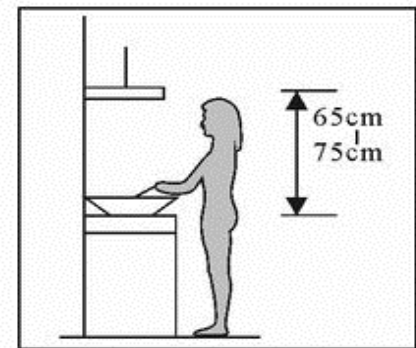

Pic 1

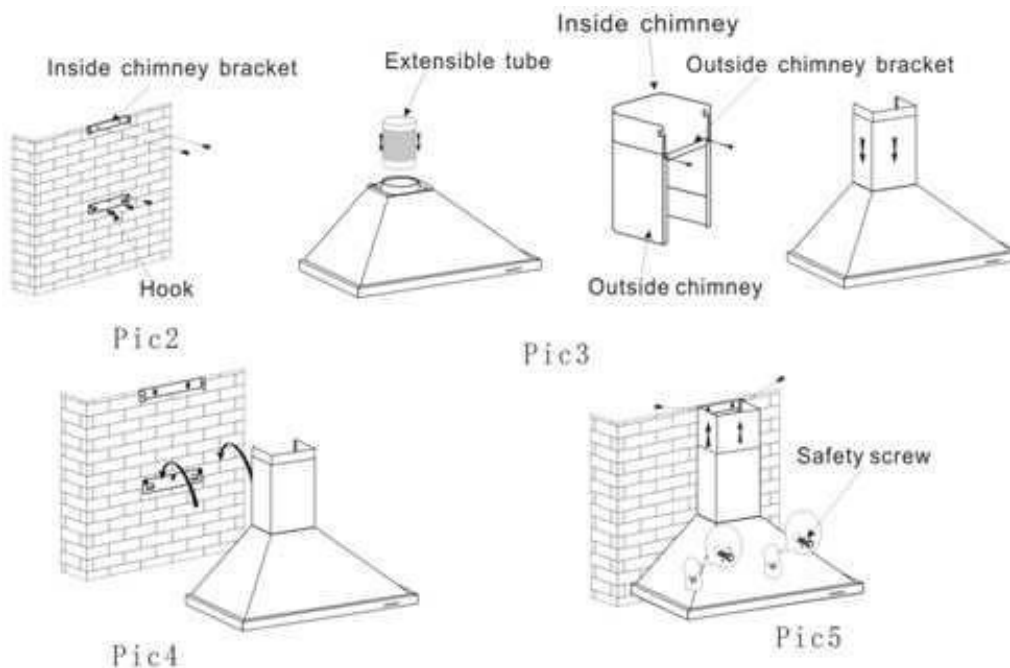

Warning: Failure to install the screws or fixing device in accordance with these instructions may result in electrical hazards.

Notice of Installation

Before installation, please ensure the area is clean, to avoid suction of the remaining bits of broken wood and dust.

The canopy hood cannot share the same air ventilation ducting as other appliances, such as gas and electric heaters.

The bending of the ventilation ducting should be $\geq 120^\circ$, parallel or above the exit vent, and should be connected through the external wall.

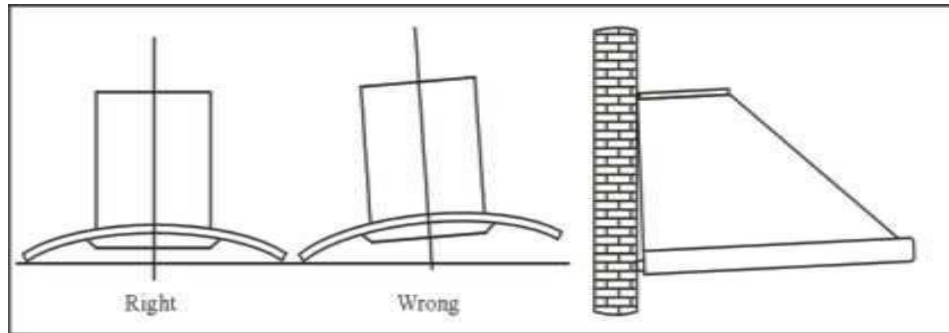

Pic5

After installation, make sure that the extractor is level to avoid grease collection at one end.

NOTE: Remove all protective plastic coatings from the stainless-steel surfaces before use.

Operating Instructions

The re-usable aluminium grease filters supplied with this rangehood should be cleaned every month or so to avoid grease build-up.

To remove the grease filter, release the locking mechanism at the front of the filter, and lower the filter slightly to unhook it at the back.

Whilst the filter is removed, clean off any residual grease from the housing to avoid fire risk.

When replacing the grease filters, ensure that the locking mechanism is facing down.

ORC93XA

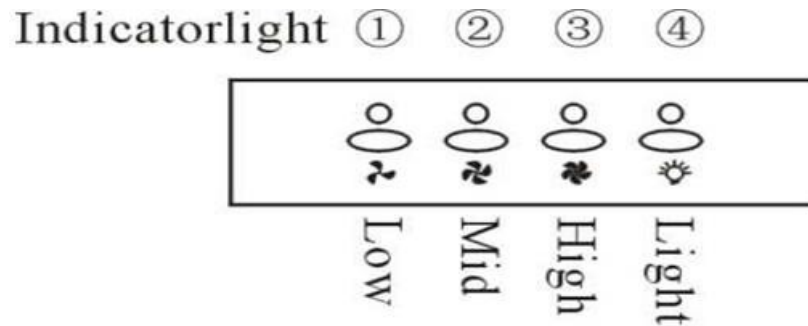

The range hood has indication diagrams to allow you to easily select the fan operating speed required.

Push the low button, indicated by a fan with 3 blades, and the motor will run at a low speed.

Push the medium button, indicated by a fan with 4 blades and the motor will run at a medium speed.

Push the high button, indicated by a fan with 5 blades and the motor will run at a high speed.

Push stop button, indicated by an (O) and the motor will stop. Push the light button, indicated by a lit globe and the two lights will come on. Push it again and the light will turn off.

Operating Instructions

ORC94XBA

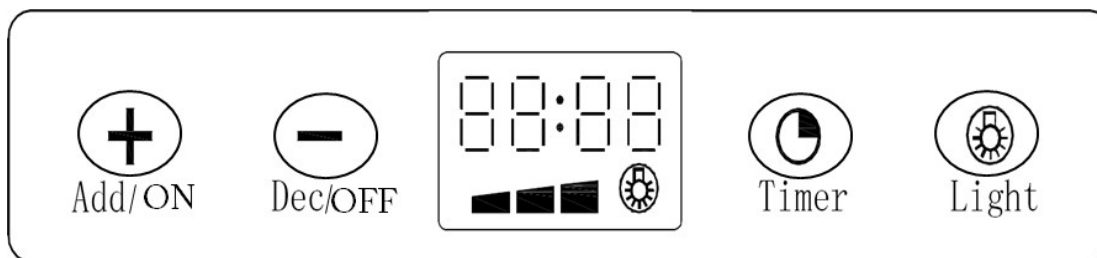

The ORC94XBA has a touch control panel.



When the power is connected and switched on you will hear a beep and the display screen will be backlit for 30 seconds and the rangehood will go into standby mode.

SETTING THE TIME (24 hour time)

In standby mode hold down the Timer button  (2-3 seconds) until the Hour symbol on the display screen starts to flash.

Touch the Add/ON **+** or Dec/OFF (-) buttons to adjust the hour. Touch the Timer button  once the hours have been set this will allow you to adjust the minutes by touching the Add/ON **+** or Dec/OFF (-) buttons.

ADJUSTING THE MOTOR SPEED

- Touch the Add/ON button **+** and the motor will run at low speed and the display screen will show .
- Touch the Add/ON button **+** again and the motor will run at medium speed and the display screen will show .
- Touch the Add/ON button **+** a third time and the motor will run at high speed and the display screen will show .

You are able to decrease the motor speed by touching the Dec/OFF button (-). Keep touching the Dec/OFF (-) button until all the bars disappear and the motor will stop and the rangehood will go into standby mode.





LIGHT

The lights work independently of the other functions. Push the light button  and the two lighting lamps will come on the display screen will also show a light symbol. Push it again and the lamps will turn off.

TIMER

The timer can be used to turn off the rangehood automatically after a period of time (5, 15 and 30 minutes).

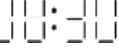
Note: The timer does not affect the lamps.

While the rangehood motor is running in any speed press the Timer button  and the display screen will show , press the Timer button again and the display will show , press the Timer button again and the display will show . If the Timer button is pressed again the display will go back to show .

Maintenance

Cleaning the Grease Filter Mesh

The filter mesh is made of high-density stainless steel. Please do not use corrosive detergent on it. Keeping this filter clean will keep the appliance running correctly. Please strictly follow the guidelines below.

- **Method 1:** Place the mesh in 40 – 50°C clean water, add in a small amount of detergent, and soak for 2 - 3 minutes. Wear gloves, and clean with a soft brush. Do not apply too much pressure, as the mesh is delicate and will damage easily.
- **Method 2:** The grease filters can be put into a dishwasher. To do so, set the temperature at around 60°C.

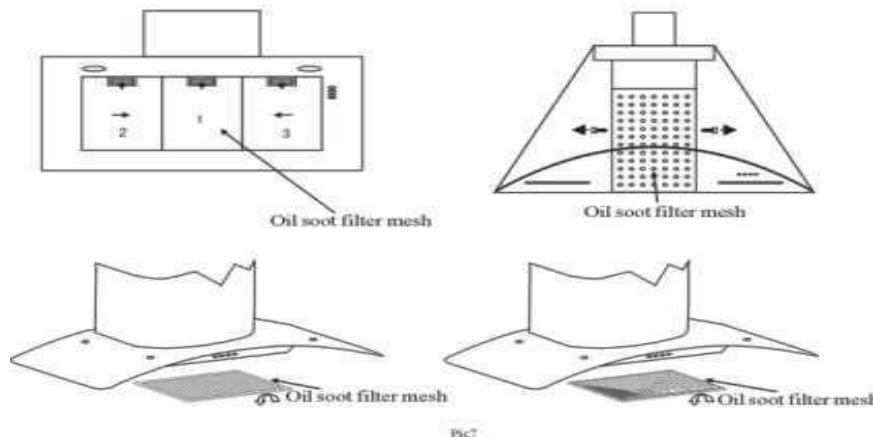

1. To protect the main body from corrosion over a long period of time, the cooker hood should be cleaned with hot water plus non-corrosive detergent every two months.
2. Please do not use abrasive detergent for it will damage the body.
3. Keep the motor and other spare parts free from water, as this will cause damage to the appliance.
4. Before cleaning the appliance please remember to turn off power
5. If fitted with active charcoal filters, the charcoal filter should not be exposed to heat.
6. Please do not tear open the fixed bar around the active charcoal filter.
7. If the supply cord is damaged, it must be replaced by the manufacturer or its service agent or a similarly qualified person in order to avoid a hazard.

Replacing the Lights

Warning: Before attempting to replace the lights, ensure that the appliance is switched off and unplugged from the wall socket.

- Remove the grease filter.
- Press the spring on either side of the lamp until it drops out (Pic. 1).
- Gently pull out the connecting wire. Disconnect the terminals (Pic. 2).
- Replace the bulb with an identical one:
 - LED modules – round lamp.
 - Max Wattage: 2 x 1.5W
 - Voltage Range: 12V DC
 - ILCOS D Code: DSR-1.5/65-S-64
- Replace the grease filter.

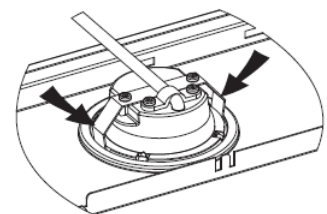

Pic 1

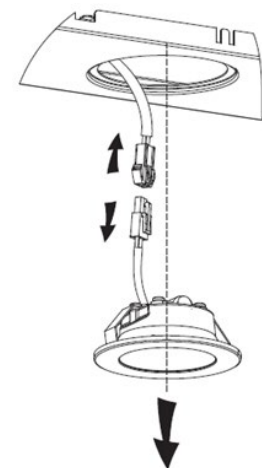

Pic 2

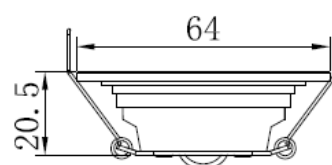

omega

omegaappliances.com.au
omegaappliances.co.nz

Warranty

WARRANTY TERMS AND CONDITIONS RANGEHOODS

This document sets out the terms and conditions of the product warranties for Residentia Group Appliances. It is an important document. Please keep it with your proof of purchase documents in a safe place for future reference should you require service for your Appliance.

1. IN THIS WARRANTY

- (a) 'acceptable quality' as referred to in clause 10 of this warranty has the same meaning referred to in the ACL;
 - (b) 'ACL' means Trade Practices Amendment (Australian Consumer Law) Act (No.2) 2010;
 - (c) 'Appliance' means any Residentia Group product purchased by you accompanied by this document;
 - (d) 'ASR' means Residentia Group authorised service representative;
 - (e) 'Residentia Group' means Residentia Group Pty Ltd of 165 Barkly Ave, Burnley VIC 3121, ACN 600 546 656 in respect of Appliances purchased in Australia;
 - (f) 'major failure' as referred to in clause 10 of this warranty has the same meaning referred to in the ACL and includes a situation when an Appliance cannot be repaired or it is uneconomic for Residentia Group, at its discretion, to repair an Appliance during the Warranty Period;
 - (g) 'Warranty Period' means:
 - (i) where the Appliance is used for personal, domestic or household use (i.e. normal single family use) as set out in the instruction manual, the Appliance is warranted against manufacturing defects for 24 months, following the date of original purchase of the Appliance;
 - (h) 'you' means the purchaser of the Appliance not having purchased the Appliance for re-sale, and 'your' has a corresponding meaning.
2. This warranty only applies to Appliances purchased and used in Australia and is in addition to (and does not exclude, restrict, or modify in any way) any non-excludable statutory warranties in Australia.

3. During the Warranty Period Residentia Group or its ASR will, at no extra charge if your Appliance is readily accessible for service, without special equipment and subject to these terms and conditions, repair or replace any parts which it considers to be defective. Residentia Group or its ASR may use remanufactured parts to repair your Appliance. You agree that any replaced Appliances or parts become the property of Residentia Group. This warranty does not apply to light globes, batteries, filters, seals or similar perishable parts.
4. Parts and Appliances not supplied by Residentia Group are not covered by this warranty.
5. You will bear the cost of transportation, travel and delivery of the Appliance to and from Residentia Group or its ASR. If you reside outside of the service area, you will bear the cost of:
 - (a) travel of an authorised representative;
 - (b) transportation and delivery of the Appliance to and from Residentia Group or its ASR, in all instances, unless the Appliance is transported by Residentia Group or its ASR, the Appliance is transported at the owner's cost and risk while in transit to and from Residentia Group or its ASR.
6. Proof of purchase is required before you can make a claim under this warranty.
7. You may not make a claim under this warranty unless the defect claimed is due to faulty or defective parts or workmanship. Residentia Group is not liable in the following situations (which are not exhaustive):
 - (a) the Appliance is damaged by:
 - (i) accident
 - (ii) misuse or abuse, including failure to properly maintain or service
 - (iii) normal wear and tear
 - (iv) power surges, electrical storm damage or incorrect power supply
 - (v) incomplete or improper installation
 - (vi) incorrect, improper or inappropriate operation
 - (vii) insect or vermin infestation
 - (viii) failure to comply with any additional instructions supplied with the Appliance;

— THIS WARRANTY IS VALID IN AUSTRALIA ONLY —

Warranty

- (b) the Appliance is modified without authority from Residentia Group in writing;
 - (c) the Appliance's serial number or warranty seal has been removed or defaced;
 - (d) the Appliance was serviced or repaired by anyone other than Residentia Group, an authorised repairer or ASR.
8. This warranty, the contract to which it relates and the relationship between you and Residentia Group are governed by the law applicable where the Appliance was purchased.
9. To the extent permitted by law, Residentia Group excludes all warranties and liabilities (other than as contained in this document) including liability for any loss or damage whether direct or indirect arising from your purchase, use or non use of the Appliance.
10. For Appliances and services provided by Residentia Group in Australia, the Appliances come with a guarantee by Residentia Group that cannot be excluded under the Australian Consumer Law. You are entitled to a replacement or refund for a major failure and for compensation for any other reasonably foreseeable loss or damage. You are also entitled to have the Appliance repaired or replaced if the Appliance fails to be of acceptable quality and the failure does not amount to a major failure. The benefits to you given by this warranty are in addition to your other rights and remedies under a law in relation to the Appliances or services to which the warranty relates.
11. At all times during the Warranty Period, Residentia Group shall, at its discretion, determine whether repair, replacement or refund will apply if an Appliance has a valid warranty claim applicable to it.
12. Missing parts are not covered by warranty. Residentia Group reserves the right to assess each request for missing parts in a case by case basis. Any parts that are not reported missing in the first week after purchase will not provide free of charge.
13. To enquire about claiming under this warranty, please follow these steps:
- (a) carefully check the operating instructions, user manual and the terms of this warranty;
 - (b) have the model and serial number of the Appliance available;
 - (c) have the proof of purchase (e.g. an invoice) available;
 - (d) telephone the numbers shown below.
14. You accept that if you make a warranty claim, Residentia Group and its ASR may exchange information in relation to you to enable Residentia Group to meet its obligations under this warranty.

IMPORTANT

Before calling for service, please ensure that the steps in point 13 have been followed.

CONTACT SERVICE

→ Service: 1300 11 HELP (4357)

The Australian Consumer Law requires the inclusion of the following statement with this warranty:

Our goods come with guarantees that cannot be excluded under the Australian Consumer Law. You are entitled to a replacement or refund for a major failure and for compensation for any other reasonably foreseeable loss or damage. You are also entitled to have the goods repaired or replaced if the goods fail to be of acceptable quality and the failure does not amount to a major failure.

— THIS WARRANTY IS VALID IN AUSTRALIA ONLY —

