

8kg/5kg Combi Clothes Washer Dryer

OFL80D50W

omega

Designed to Enhance
EST. 1981

@omegaappliances_au
omegaappliances.com.au

Contents

Welcome	03
Safety Information	04
Your Combi Washer Dryer	07
Installation Instructions	08
Quick Start Guide	10
Operating Instructions	11
Cleaning & Maintenance	18
Troubleshooting	20
Purchase Details	23
Warranty Information	26

Welcome

Residentia Group

—

Head Office

165 Barkly Avenue
Burnley Victoria
Australia 3121

—

ACN

600 546 656

—

Online

residentia.group
omegaappliances.com.au
@omegaappliances_au

—

Postage

PO BOX 5177, Burnley
VIC Australia 3121

—

Telephone

1300 11 4357

—

Email

support@residentia.group

Congratulations on purchasing your Combi Washer Dryer. Omega appliances are proudly owned and distributed within Australia by Residentia Group Pty Ltd.

Please refer to the warranty chapter at the rear of this manual for information regarding your product's parts and labour warranty, or visit us online at:

→ residentiagroup.com.au

Here at Residentia Group, we are customer obsessed and our Support Team are there to ensure you get the most out of your appliance. Should you want to learn more about your unit, and importantly, taking care of the appliance, our Support Team are here to help. You can use our online Support Centre at any time by visiting:

→ support.residentiagroup.com.au

Or you can contact us by dialling: 1300 11 HELP (4357)

It is important that you read through the following user manual thoroughly, in order to familiarise yourself with the installation and operation requirements of your appliance, and to ensure optimum performance.

Again, thank you for choosing an Omega appliance. We look forward to being of service to you.

Kind Regards,
The Residentia Team

Customer Care

—

At Residentia Group, we strongly encourage the use of authentic spare parts to guarantee the best results. When contacting our spare parts team through 1300 11 HELP, or by emailing parts@residentiagroup.com.au, please ensure that you have the model and serial numbers on hand, which are found on your appliances' rating plate.

Safety Information

Intended Use

- The product is intended only for domestic home use and for textiles in household amounts suitable for washing.
- This appliance is for indoor use only and not intended for built in use. Only use according to these instructions.
- The appliance is not intended for commercial use.
- Any other use is considered as improper use. The manufacturer is not responsible for any damage or injury that may result from it.
- This appliance is intended to be used in household and similar applications such as:
 - Staff kitchen areas in shops, offices and other working environments;
 - Farm houses;
 - By clients in hotels, motels and other residential type environments;
 - Bed and breakfast type environments;
 - Areas for communal use in blocks of flats or in launderettes.

Key Words

- **DANGER:**
This key word indicates that there are dangers to the life and health of persons due to extremely flammable gas.
- **ELECTRICAL WARNING:**
These key words indicates that there is a danger to life and health of persons due to voltage.
- **WARNING:**
This key word indicates a hazard with a medium level of risk which, if not avoided, may result in death or serious injury.
- **CAUTION:**
This key word indicates a hazard with a low degree of risk which, if not avoided, may result in minor or moderate injury.
- **NOTE:**
This key word indicates important information (e.g. damage to property or appliance), but not danger.
- **OBSERVE INSTRUCTIONS**
These key words indicates that a service technician should only operate and maintain this appliance in accordance with the operating instructions.

Important Safety Instructions

- Please read the following safety information thoroughly and follow it strictly to minimize the risk of fire or explosion, electric shock and to prevent property damage, personal injury or loss of life. Failing to follow these instructions shall void any warranty.
- This appliance is not intended for use by persons (including children) with reduced physical, sensory or mental capabilities, or lack of experience and knowledge, unless they have been given supervision or instruction concerning use of the appliance by a person responsible for their safety.
- **ELECTRICAL WARNING: ELECTRIC SHOCK HAZARD**
If the supply cord is damaged, it must be replaced by the manufacturer, its service agent or similarly qualified persons in order to avoid a hazard.
- If the machine is damaged, it must not be operated unless repaired by the manufacturer, its service agent or similarly qualified persons.
- Risk of electric shock!
- The appliance can be used by children aged from 8 years and above and persons with reduced physical, sensory or mental capabilities or lack of experience and knowledge
- if they have been given supervision or instruction concerning use of the appliance in a safe way and understand the hazards involved. Children shall not play with the appliance. Cleaning and user maintenance shall not be made by children without supervision.
- Children should be supervised that they do not play with the appliance.
- Children 3 years and under shall be kept away from the appliance or continuously supervised.
- Animals and children may climb into the machine. Check the machine before every operation.
- Do not climb or sit on the appliance.

Safety Information (Continued)

Installation Location and Surrounding

- All washing and additional substances are to be kept in a safe place out of the reach of children.
- Do not install the machine on a carpet floor.
- The obstruction of the openings by a carpet can damage the machine.
- Keep the appliance clear from heating sources and direct sunlight to avoid plastic and rubber parts to corrode.
- Do not use the appliance in humid environments or rooms containing explosive or caustic gas. In case of water leakage or water splashes, let the appliance dry in the open air.
- The appliance must not be installed behind a lockable door, a sliding door or a door with a hinge on the opposite side to that of the machine .
- Do not operate the machine in rooms with a temperature of below 5°C. This can cause damages to parts of it. If it is unavoidable, make sure to drain the water completely from the appliance after every use (see “Maintenance - Cleaning of drain pump filter”) to avoid damages caused by frost.
- Never use flammable sprays or substances in the immediate proximity of the appliance.
- That lint must not to be allowed to accumulate around the washer dryer (not applicable for appliances intended to be vented to the exterior of the building).

Installation

- Remove all packaging material and transport bolts before using the appliance. Otherwise, serious damage may result.
- This appliance is equipped with a single inlet valve and can be connected to the cold water supply only.
- Mains plug must be accessible after installation.
- Before washing clothes for the first time, the product shall be operated once throughout all the procedures without any clothes inside.
- Before using the machine, the product shall be calibrated.
- Do not put any excessively heavy objects on the appliance, like water containers or heating devices.
- The new hose-sets supplied with the appliance are to be used and that old hose-sets should not be reused.
- Max. Inlet water pressure 1 MPa. Min. inlet water pressure 0.05 MPa.

Electrical Connection

- Make sure the supply cable is not trapped by the machine, or it can get damaged.
- Connect the product to a grounded outlet protected by a fuse complying with the values in the "Technical specifications" table. The grounding installation has to be made by a qualified electrician. Ensure that the machine is installed in accordance with the local regulations.
- Water and electrical connections must be carried out by a qualified technician in accordance with the manufacturer's instructions and local safety regulations.
- **WARNING:** Don't use multiple plugs or extension cords.
- The appliance must not have an external switching device such as a timer or connected to a circuit that is regularly switched on and off.
- Do not pull the plug out of the mains outlet if there is flammable gas around.
- Never pull out power plug with wet hands.
- Always pull at the plug, not at the cable.
- Always unplug the appliance if it is not being used.

Water Connections

- Check the connections of the water inlet tubes, the water tap and the outlet hose for possible problems due to changes of water pressure. If the connections loosen or leak, close the water tap and get it repaired.
- Do not use the appliance before the pipes and hoses are installed properly by qualified persons.
- Glass door may become very hot during the operation. Keep children and pets far away from the machine while it is operating.
- The water inlet and outlet hoses have to be safely installed and remain undamaged. Otherwise, water leakage can occur.
- Do not remove the drain pump filter while there is still water in the appliance. Big quantities of water can leak out, and there is a risk of scalding due to hot water.

Safety Information (Continued)

Operation and Maintenance

- **WARNING:** Never stop the machine before the end of the drying cycle unless all items are quickly removed and spread out so that the heat can dissipate.
- The machine is not to be used if industrial chemicals have been used for cleaning. Risk of explosion.
- Never use any flammable, explosive or toxic solvents. Do not use gasoline and alcohol etc. as detergents. Only select detergents that are suitable for machine washing.
- Make sure that all pockets are emptied. Sharp and rigid items such as coins, brooches, nails, screws, stones etc. may cause serious damages to this machine.
- Remove all objects from pockets such as lighters and matches before use the appliance.
- Thoroughly rinse items that have been washed by hand.
- Do not dry unwashed items in the appliance.
- Items that have been soiled with substances such as cooking oil, acetone, alcohol, petrol, kerosene, spot removers, turpentine, wax and wax removers should be washed in hot with an extra amount of detergent before being dried in the appliance.
- Items containing foam rubber (latex foam), shower caps, water proof textiles, rubber backed articles and clothes or pillows fitted with foam rubber pads should not be dried in the machine.
- Fabric softeners or similar products should be used are recommended in their instructions.
- Never try to open the door forcefully.
- The door will unlock shortly after the end of a cycle.
- Please do not close the door with excessive force. If it is found difficult to close the door, please check if the clothes are properly inserted and distributed.
- Always unplug the appliance and close the water tap before cleaning and maintenance and after each use.
- **ELECTRICAL WARNING: RISK OF ELECTRIC SHOCK!** Never pour water over the appliance for cleaning purpose.
- Repairs shall only be carried out by the manufacturer, its service agent or similarly qualified persons in order to avoid a hazard.
- The producer will not be responsible for damages caused by the intervention of not authorised persons.

Transport

- Before Transport:
 - Bolts shall be reinstalled to the machine by a specialised person;
 - Accumulated water shall be drained out of the machine.
- This appliance is heavy. Transport with care. Never hold any protruding part of the machine when lifting. The machine door can not be used as a handle.

Disposal of Packaging

The packaging is designed to protect the appliance from damage during transportation. The packaging materials are environmentally friendly and should be recycled. Recycling the packaging can reduce the use of raw materials in the manufacturing process and the amount of waste in landfill sites.

Packaging materials of the product are manufactured from recyclable materials in accordance with our National Environment Regulations. Do not dispose of the packaging materials together with the domestic or other wastes. Take them to the packaging material collection points designated by the local authorities.



Disposal & Recycling

Important Instructions for Environment

Compliance with the WEEE Directive and Disposing of the Waster Product: This product complies with EU WEEE Directive (2012/19/EU). This product bears a classification symbol for waster electrical and electronic equipment (WEEE).

This symbol indicates that this product shall not be disposed with other household wastes at the end of its service life. Used device must be returned to official collection point for recycling of electrical electronic devices. To find these collection systems please contact to your local authorities or retailer where the product was purchased. Each household performs important role in recovering and recycling of old appliance. Appropriate disposal of used appliance helps prevent potential negative consequences for the environment and human health.



Your Combi Washer Dryer

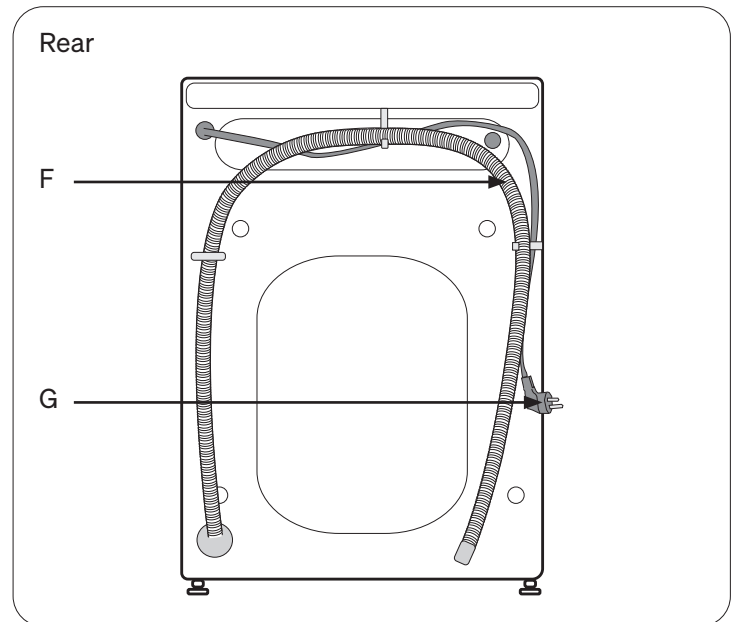
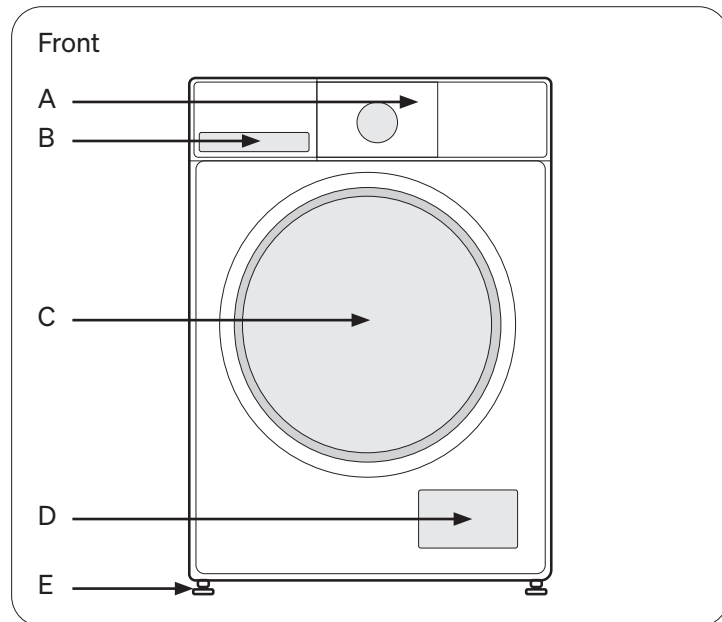

A. Control Panel

B. Detergent Dispenser

C. Door

D. Service Panel

E. Adjustable Feet

F. Drain Hose

G. Power Supply Cord

Product Specifications

Model	OFL80D50W
Washing Capacity	8.0 kg
Drying Capacity	5.0 kg
Dimensions (W × D × H)	595 × 535 × 850 mm
Depth with door open	1045 mm
Weight	66 kg
Rated Power	1900W
Drying Power	1300W
Power Supply	220-240V~, 50Hz
Max. Current	10A
Standard Water Pressure	0.05MPa-1MPa

Parts and Accessories

Your Combi Washer Dryer comes with the following accessories:

- 4 × Cover caps (for transport bolt holes)
- 1 × Cold water supply hose
- 4 × Acoustic sponge strips
- 1 × User Manual
- 1 × Quick Start Guide

NOTE: The diagrams in this user manual are for explanatory purposes only. Your appliance may appear differently.

Installation Instructions

Prior to Installing the Combi Washer Dryer

IMPORTANT: If the power cord is damaged, it must be replaced by Residentia Group or one of its authorised service representatives. Please contact 1300 11 HELP (4357) and ensure the appliance is completely disconnected from the power supply.

Possible Tools Required for Installation

WARNING: Please ensure that all power is switched off before installing the appliance.

- Drill and Screwdriver
- Hole Saw Drill Bit for electrical cables & plugs
- Spirit Level and Tape Measure
- Pencil and Cable Ties

Installation Area

- **WARNING:** Stability is important to prevent the product from wandering! Ensure the appliance is standing levelled and stable.
- **WARNING:** Make sure that the product does not stand onto the power cord.
- **WARNING:** Make sure to maintain the minimum distance of 20mm from each wall.

Before installing the machine, ensure that the installation position adheres to the following conditions:

- Rigid, dry, and level surface.
- Avoid direct sunlight.
- Sufficient ventilation.
- Room temperature is above 5 °C .
- Keep far away from the heat sources such as coal or gas burning appliances.

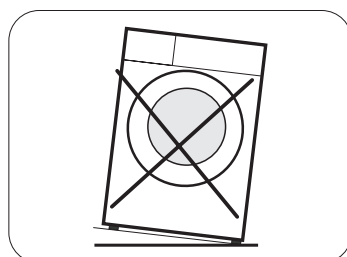
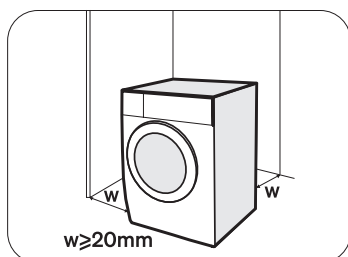

Unpacking the Appliance

WARNING: Risk of suffocation

Packaging material (e.g. Films, Styrofoam) can be dangerous for children. Keep all packaging well away from children.

1. Remove the cardboard box and styrofoam packing.
2. Lift the machine and remove the base packaging. Make sure the small triangle foam (a) is removed with the bottom packaging together. If not, lay the unit down on the side surface and remove it manually.
3. Remove the tape securing the power supply cord and drain hose.
4. Remove the inlet hose from the drum.

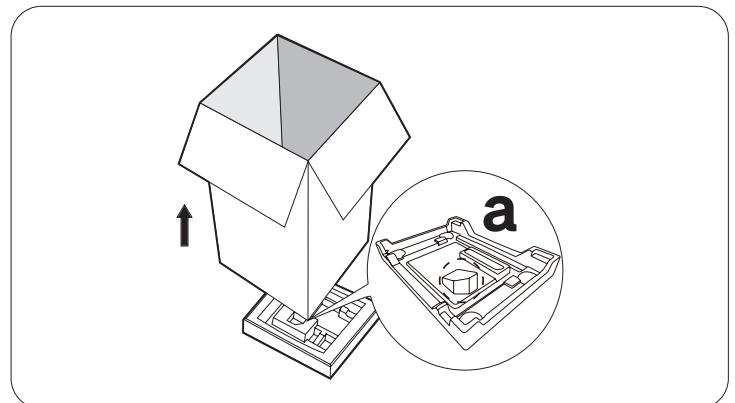

Levelling the Appliance

WARNING: The lock nuts on all four feet must be screwed tightly against the housing.

1. Loosen the lock nut.
2. Turn the foot until it reaches the floor.
3. Adjust the legs and lock the nuts with a spanner. Make sure the machine is level using a spirit level.

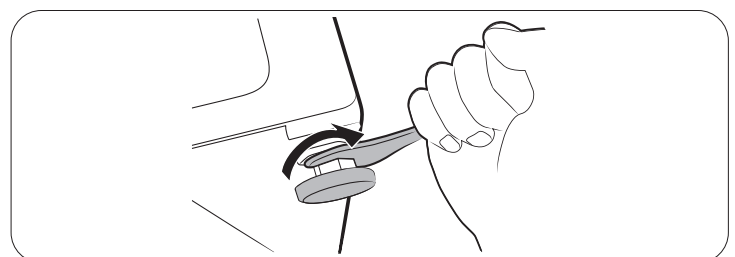

Installation Instructions (Continued)

Removing the Transport Bolts

WARNING: You must remove the transport bolts from the backside before using the product.

1. Loosen the 4 transport bolts with a spanner.

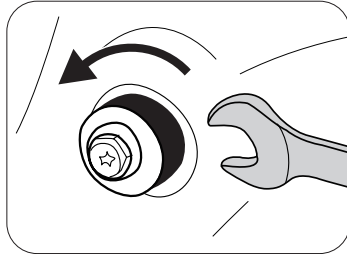

2. Remove the bolts including the rubber parts and keep them for future use.

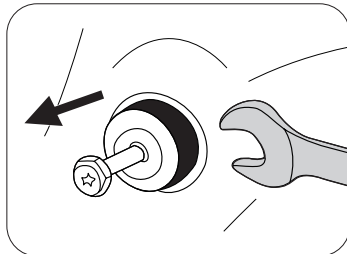

3. Close the holes using the cover caps.

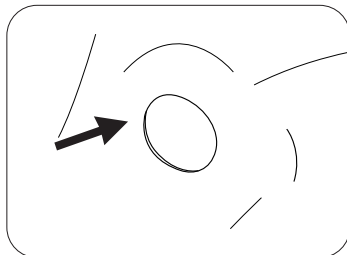

Acoustic Sponge

NOTE: Please make sure to assemble the acoustic sponge strips, which can effectively reduce the noise caused by the machine while working, in order to provide you with a more peaceful and quiet living environment.

1. Lay the machine on the floor, using some soft material like foam or clothes between the machine and floor for protection.
2. Apply the 2x longer sponges to the long bottom edges of machine, and the 2x shorter sponges to the short edges.

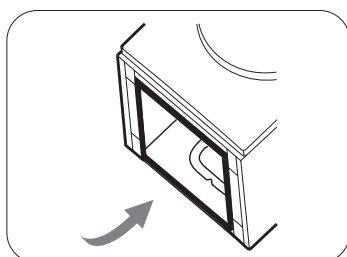
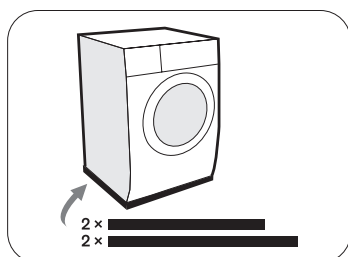

Connect the Water Supply Hose

- **WARNING:** To prevent leakage or water damage, follow the instructions in this chapter.
- **WARNING:** Do not kink, crush or modify water inlet hose.
- Connect the water supply hose to the water inlet valve and a water tap with cold water as indicated.

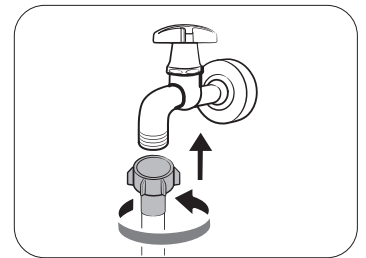
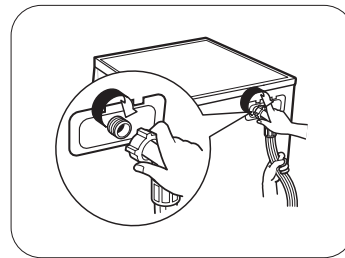

- **NOTE:** Check if the connections are tight. Connect manually, do not use tools.

Drain Hose

- **WARNING:** Do not kink or protract the drain hose.
- **WARNING:** Position drain hose properly, otherwise damage might result in water leakage.
- **WARNING:** Do not remove the buckle of the drain pipe.

The are two optional ways to place the end of the drain hose.

1. Put it into the water trough.

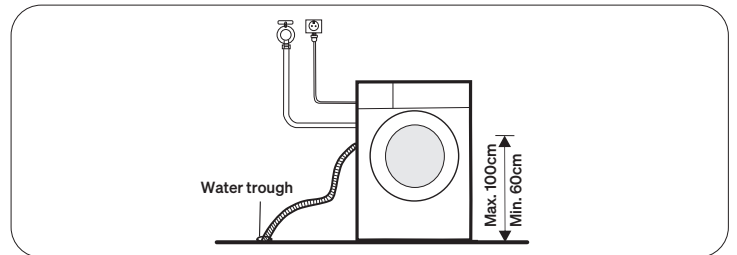

2. Connect it to the branch drain pipe of the trough.

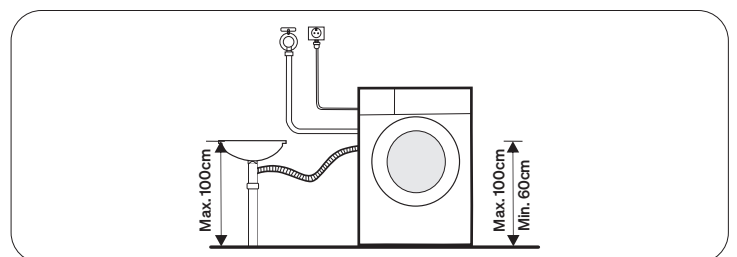

Quick Start Guide

Prior to Operating the Combi Washer Dryer

- **CAUTION:** Before washing, please make sure the machine is installed properly.
- **CAUTION:** Clean your appliance before first use. Your appliance was thoroughly checked before it left the factory. To remove any residual water and to neutralise potential odours, we recommend to clean the inner drum by running the "Drum Clean" or other program with the optional temperature of 90° C. Be careful not to put laundry and detergent in the machine when performing the Drum Clean program.

Before Operation

1. Plug the power plug into the power socket.

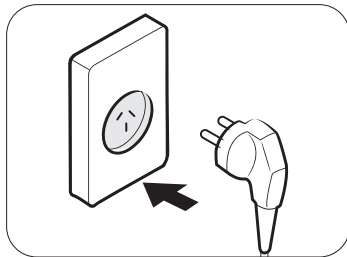

2. Open the tap

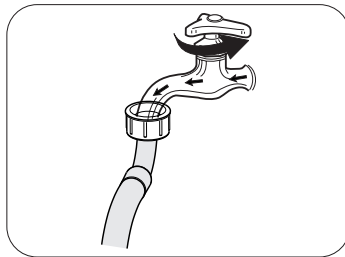

3. Load the laundry items and close the door

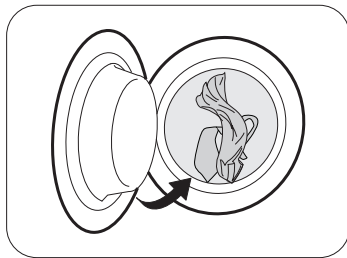

4. Add detergent

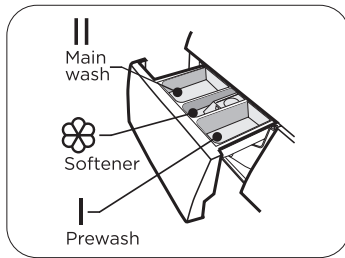

NOTE: Detergent needs to be added in compartment I if the pre-wash function is selected.

Operating your Combi Washer Dryer

1. Power on

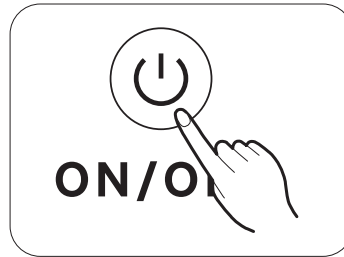

2. Select program

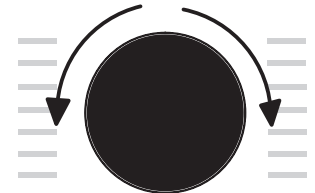

3. Select any options or additional functions or keep the default settings

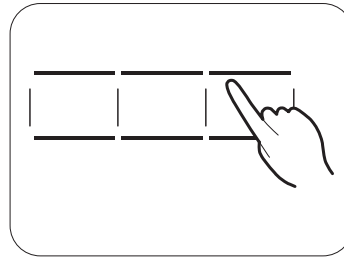

4. Press Start/Pause to start to program

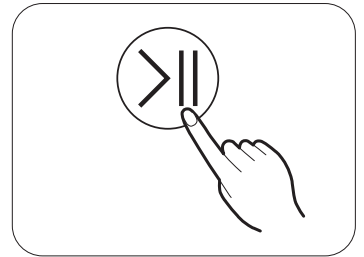

NOTE: At the end of the cycle, the machine will sound an alert and "End" will be shown on the display.

Operating Instructions

Before Each Washing Cycle

- The ambient temperature of the machine should be 5°C-40°C. If used under 0°C, the inlet valve and draining system may be damaged. If the machine is installed under freezing conditions, it should be transferred to normal ambient temperature to ensure the water supply hose and drain hose can unfreeze before use.
- Please check your laundry care labels and the detergent use instructions before wash. Use non-foaming or less-foaming detergent suitable for machine properly.

1. Remove any items from the pockets

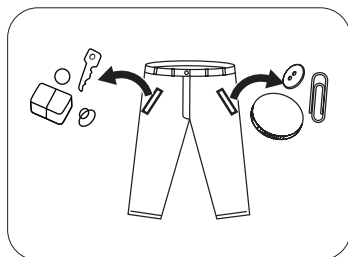

2. Sort laundry according by colour and textile type

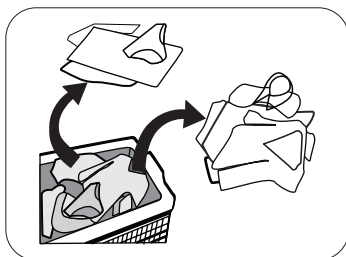

3. Tie together long textile strings and belts, close zips and button

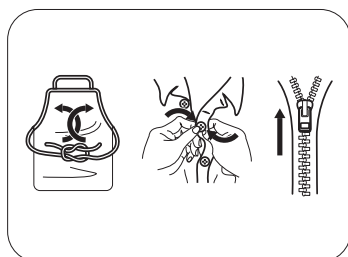

4. Place delicate or small items into a laundry bag

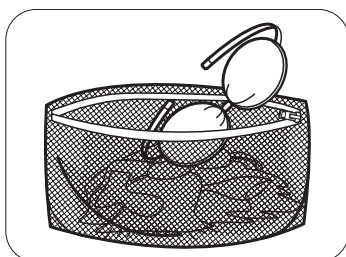

- **WARNING:** Do not wash or dry articles that have been cleaned in, washed in, soaked in, or dabbed with combustible or explosive substances like wax, oil, paint, gasoline, alcohol, kerosene, and other flammable materials.
- **WARNING:** Washing single clothing items may easily create big eccentricity. Therefore it is suggested to add one or two more laundry items to the wash so that spin can be done smoothly.
- **WARNING:** Do not wash, spin water-proof seats, mats, or clothing.

The Detergent Dispenser

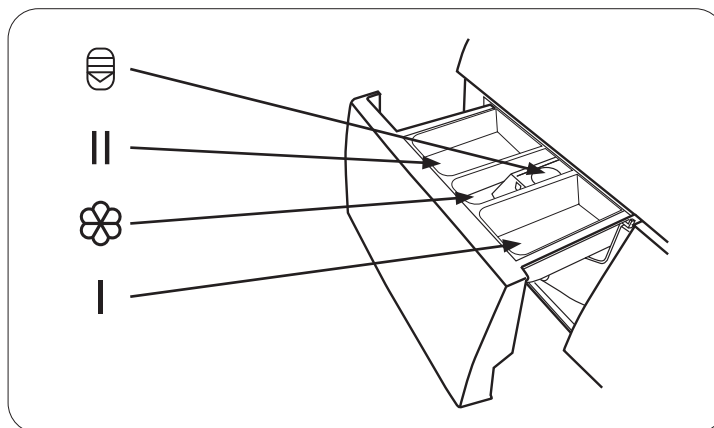

- I Prewash
- II Main Wash
- Softener
- Release button to pull out the dispenser

- **CAUTION:** Detergent only need to be added in "compartment I" after selecting pre-wash function.
- **CAUTION:** Do not put laundry beads into the detergent dispenser.
- Refer to the table on page 16 for detergent and softener recommendations based on the program type.

Operating Instructions (Continued)

Control Panel

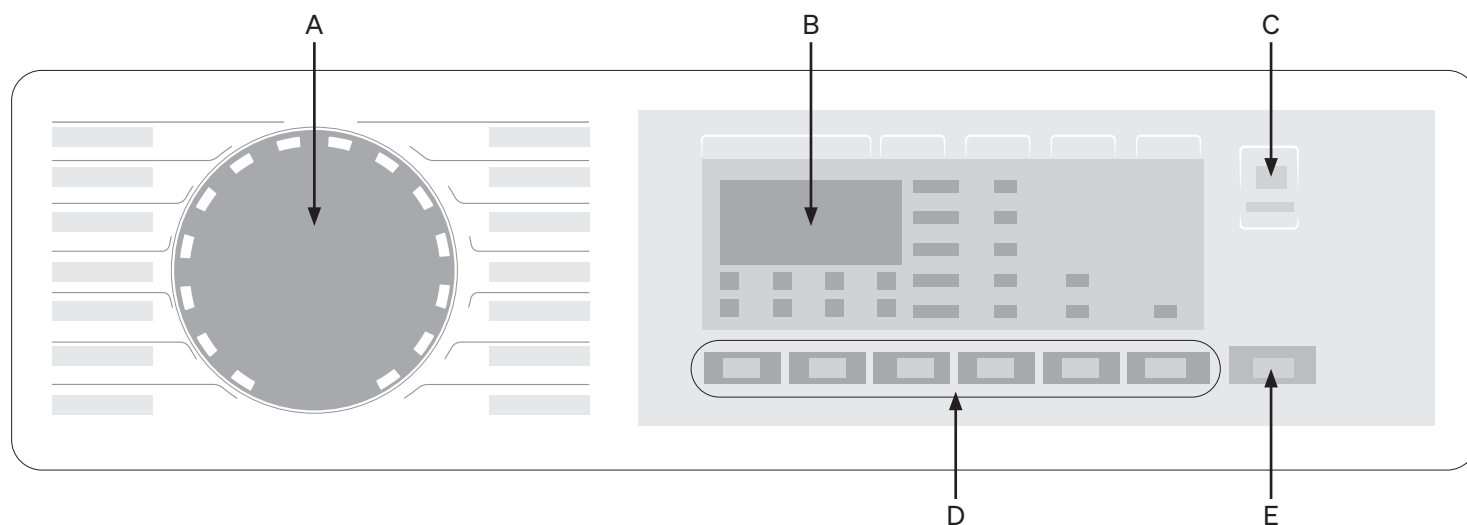

A. Program selection dial

B. LED Display: Showing settings, estimated remaining time, options and status messages.

C. Power button

D. Extra Options: Press these buttons to change the program parameters or select additional functions.

E. Start/Pause button

LED Display

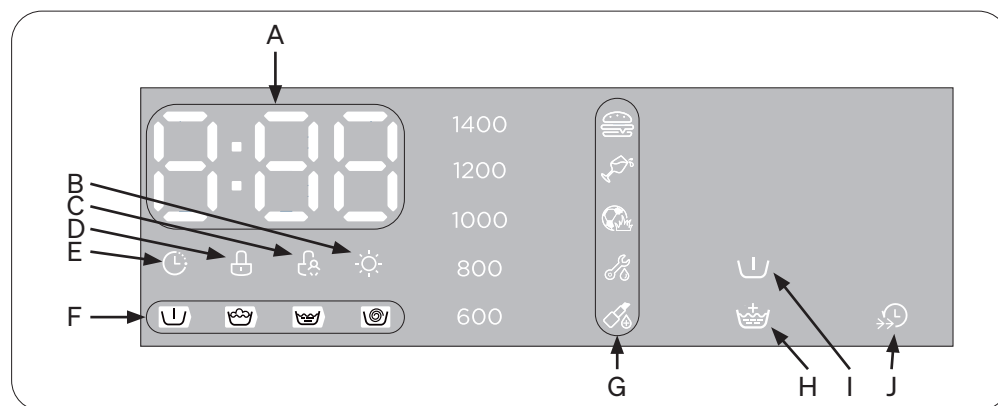

A. Display
Wash Time
1:25

Delay Time
2H

Speed
500

Error
E30

End
End

Temp
30

B. Dry

E. Delay Start

H. Precise Purify

C. Child Lock

F. Pre Wash → Wash → Rinse → Spin

I. Pre Wash

D. Door Lock

G. Extra Rinse

J. Speed Wash

NOTE: The diagram images in this user manual are for explanatory purposes only. Your appliance may appear differently.

Operating Instructions (Continued)

Program Functions



Personalised

To save your most frequently used program and settings. After selecting the settings and any additional options, press the Spin Speed and Precise Purify buttons for 3 seconds before beginning the cycle. The default program is set to Cotton.



Cotton

Hard-wearing textiles, heat-resistant textiles made of cotton or linen.



Mix

Mixed load consisting of textiles made of cotton and synthetics.



Baby

Washing using the Baby function can make the baby's wear cleaner and make the rinse performance better to protect the baby skin.



Wool

Hand or machine-washable wool or rich wool textiles. Especially gentle wash program to prevent shrinkage, longer program pauses (textiles rest in wash liquid).



Drum Clean

Specially set in this machine to clean the drum and tube. It applies 90 °C high temperature sterilisation to make the clothes washing more clean. When this program is performed, the clothes or other washing cannot be added. When proper amount of chlorine bleaching agent is put in, the barrel cleaning effect will be better. The customer can use this programme regularly according to the need.



Spin Only

Spins and drains the water.



Quick 15' / 1h WD

This procedure defaults to Quick 15', press the "Dry" to switch to 1h WD.

Quick 15' is suitable for washing few and not very dirty clothes quickly.

1h WD (1 hour Wash & Dry) is suitable for small synthetic clothes or shirts, load limitation is 1 kg (about 4 shirts).



Steam Shield

Steam is applicable for daily laundries.

The steam can deeply penetrate the fibre, which effectively eliminate bacteria and germs, preventing odours and protecting your health.



Cotton ECO

Energy-saving program for hard-wearing textiles, heat-resistant textiles made of cotton or linen.



20° C

Program suitable for lightly soiled cotton laundry, at a nominal temperature of 20 °C.



Wash & Dry

The standard energy program for washing and drying.



Auto Dry

This program is designed for drying clothes automatically to achieve the best dry performance.



Time Dry

Select drying as a set time.

Operating Instructions (Continued)

Extra Options

Pre Wash

Extra washing function before the main washing cycle starts to increase the washing performance.

NOTE: Detergent needs to be added to the compartment I.

Extra Rinse





This function will add an additional extra rinse cycle.

Speed Wash

The function can decrease the washing time.

Precise Purify

Precise Purify offers specific treatments for five scenarios (Food, Drinks, Sports, Outdoor Work and Beauty) to intelligently solve according laundry requirements.

Icon	Scenario	Wash Cycle	Typical Stain
	Food	Cotton, Mix, Baby	Vegetables, juice and sauces
	Drinks	Cotton, Mix, Baby	Red wine, hot beverage or soft drinks
	Sports	Cotton, Mix	Grass, dust or sweat stains
	Outdoor Work	Cotton, Mix	Grease, mud or carbon pigments
	Beauty	Cotton, Mix	Cosmetic, blood or chemical

Mute

Press the Start, then press Precise Purify & Extra Option buttons together for 3 seconds. This setting will remain until the next reset.

NOTE: After activating the mute function, sounds will not be activated anymore.

Dry Level

Press the Dry button continuously to choose the dry level: Standard Dry → Extra Dry → Light Dry → Time Dry.

- **D-1:** Light Dry
- **D-2:** Standard Dry
- **D-3:** Extra Dry

Drying hints

- Clothes could be dried after spinning
- To ensure quality dry the textiles, please classify them according to their kinds and the drying temperature.
- Synthetic should be set the proper drying time.
- If you want to iron clothes after drying, we recommend drying them only for a short period.

Clothes not suitable for drying

- Particularly delicate items such as synthetic curtains, wool and silk, clothes with metal inserts, nylon stockings, bulky clothes, such as anoraks, bed covers, quilts, sleeping bags and duvets must not be dried.
- Clothes padded with foam-rubber or materials similar to foam-rubber must not be machine dried.
- Fabrics containing residues of setting lotions or hair sprays, nail solvents or similar solutions must not be machine dried in order to avoid the formation of harmful vapours.

Delay Start

Please follow the steps as bellow:

1. Select a program
2. Press the Wash Temp and Spin Speed buttons for 3 seconds to choose the delaying time between 0-24H.
3. Press the Start/Pause button to begin the delay operation.

NOTE: To cancel the Delay function, press the two buttons before starting the program until the display shows OH. If the program has already started, switch the appliance off and on again, then select a new program.

Operating Instructions (Continued)

WASH TEMP **Washing Temperature**

When required, the washing temperature can be adjusted by pressing the temperature button in the following steps:
Cold → 20° C → 30° C → 40° C → 60° C → 90° C

SPIN SPEED **Spin Speed**

When required, the spinning speed can be adjusted by pressing the Spin Speed button in the following steps:
0 → 600 → 800 → 1000 → 1200 → 1400

RELOAD **Reload**

This operation can be executed during the washing progress. When the drum is still rolling and there is large amount of water with high temperature in the drum making it unsafe to open the door – it can also not be opened forcefully. To begin the Reload function, press the Start/Pause button for 3 seconds to add the clothes mid cycle.

Please follow the steps as bellow:

1. Wait until the drum stops rotating.
2. The door lock is unlocked.
3. Add in your additional laundry
4. Close the door and press the Start/Pause button.

CAUTION: Do not use the Reload function when the water level is over the edge of the inner tub or the temperature is high.

Child Lock

Use this function to avoid any misuse of the controls. To activate, press the Extra Option & Speed Wash buttons together for 3 seconds until an alert sounds and the Child Lock indicator is displayed.

- **CAUTION:** When activated, the display will alternately show “CL” and the remaining time.
- Pressing any other buttons will cause the Child Lock indicator to flash.
- When the program ends, “CL”& “End” will alternate on the display.
- The Child Lock deactivates the function of all buttons except the On/Off button and the Child lock button combination. Only by simultaneous pressing Extra Option & Speed Wash can deactivate the Child Lock.
- Please deactivate the Child Lock before selecting a new program.

Refer to the table on page 16 for the availability of additional functions based on the program type.

Operating Instructions (Continued)

Washing Program Table

Program	Wash/Dry Load (kg)	Temp. (°C)	Default Speed (RPM)	Default Time (h:min)	Pre Wash	Main Wash	Fabric Softener	Additional Functions
Quick 15'/1h WD	2.0/1.0	—	800 / 1400	0:15 / 0:58	—	Required	Optional	☰ ☑ ☀
Steam Shield	4.0/2.5	60	1000	2:28	Optional	Required	Optional	☰ ⌋ ☑ ☰ ☰ ☀
Cotton ECO	8.0/—	30	1000	0:59	—	Required	Optional	☰ ☑ ☰
20°C	4.0/—	20	1000	1:01	—	Required	Optional	☰ ☑ ☰
Wash & Dry	8.0/5.0	40	1400	5:16	—	Required	Optional	☰ ☀
Auto Dry	—/5.0	—	1200	4:09	—	—	—	☰ ☀
Time Dry	—/5.0	—	1200	0:40	—	—	—	☰ ☀
Spin Only	8.0	—	1000	0:12	—	—	—	☰
Drum Clean	—	90	—	1:18	—	—	—	☰
Wool	2.0/—	40	600	1:07	—	Required	Optional	☰ ☑
Baby	8.0/5.0	60	1000	2:01	Optional	Required	Optional	☰ ⌋ ☑ ☰ ☰ ☀
Mix	8.0/5.0	40	1000	0:58	Optional	Required	Optional	☰ ⌋ ☑ ☰ ☰ ☀
Cotton	8.0/5.0	40	1000	1:28	Optional	Required	Optional	☰ ⌋ ☑ ☰ ☰ ☀

- Energy test program Cotton ECO / Auto Dry.
Cotton ECO: Speed: the highest speed; Temp. : 60°C. Other as the default.
Half load for 8.0kg machine: 4.0kg.
Quarter load for 8.0kg machine: 2.0kg.
Auto Dry: Speed: the highest speed; Dry Level: D-3. Other as the default.
Load for 8.0kg machine: 5.0kg.
Half load for 5.0kg machine: 2.5kg.
- "Cotton ECO" is the standard washing programs to which the information in the label and the fiche relates, and they are suitable to clean normally soiled cotton laundry and that they are the most efficient programmes in terms of combined energy and water consumptions for washing that type of cotton laundry, that the actual water temperature may differ from the declared cycle temperature.
- **NOTE:** The parameters in this table are only for user's reference. The actual parameters maybe different with the parameters in above mentioned table

Operating Instructions (Continued)

Testing Methods

Model: OFL80D50W

ADDITIONAL INFORMATION FOR Standard performance TESTING: (AS/NZS 2040.1:2005+Amdt1-2007+Amdt2-2009)

1. Water connections: Cold & hot water connection
2. Water supply pressure: 320 kPa
3. Energy Wash Program: Cotton ECO, 1400rpm,60°C, Display: 6:32
Energy Dry program: Auto Dry, 1400rpm, D-3, Display: 4:39
4. Detergent type: Drum detergent
5. Detergent quantity: Default
6. Adding detergent:
The detergent is dissolved and added as Paragraph B7.3 of AS/NZS 2040.1
The detergent shall be dissolved in 1 L of water
7. Anti-sudsing agent: Max
8. Test load mass: 8.0kg
9. Water consumption: 68L
10. Test Voltage:220-240V~, 50Hz

Cleaning & Maintenance

Cleaning & Care

WARNING: Always unplug the appliance and close the water tap before cleaning and maintenance.

Cleaning the Cabinet

- Proper maintenance on the machine can extend its working life.
- The surface can be cleaned with diluted nonabrasive neutral detergents when necessary.
- If there is any water overflow, use a towel to wipe it off immediately.
- Never use sharp items to clean the appliance.
- **CAUTION:** Never use abrasive or caustic agents. Such as formic acids or its diluted solvents or similar substances, like alcohol or chemical products.

Cleaning the Drum

- Any rust stains left inside the drum by metal articles must be removed immediately using chlorine-free detergents. Never use steel wool for cleaning the drum!
- **NOTE:** Do not place any laundry into the machine when cleaning the drum.

Cleaning the Door Seals & Glass

- Wipe the glass and seal after each wash to remove lint and stains. If lint builds up it can cause leakages.
- Remove any coins, buttons and other objects from the seal after each wash.
- Clean the door seal and glass every month to ensure the normal operation of the appliance.

Cleaning the Inlet Filter

NOTE: Diminishing water flow is a sign that the filter needs to be cleaned.

1. Close the tap and remove the water supply hose from it.
2. Clean the filter with a brush.

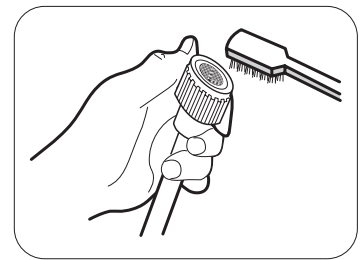
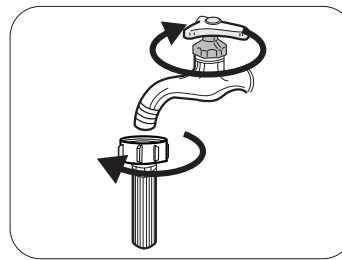

3. Unscrew the water supply hose from the backside of the machine. Pull out the filter with long pliers.
4. Use a brush to clean the filter.

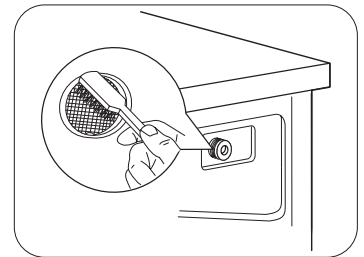
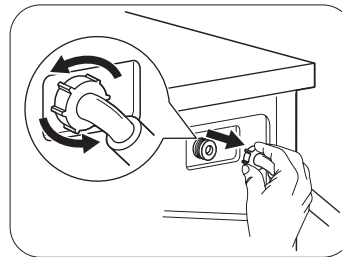

5. Reinstall the filter to the water inlet and reconnect the water supply hose.
6. Clean the Inlet filter every 3 months to ensure the normal operation of the appliance.

Cleaning & Maintenance (Continued)

Cleaning the Detergent Dispenser

1. Press down the release  on the softener cover and pull the dispenser drawer out of the recess. Clean the inside of the recess with a brush.
2. Lift the softener cover off the dispenser drawer and wash both items with water.
3. Restore the softener cover and push the drawer back into the recess.

1. Press the release and remove the dispenser drawer

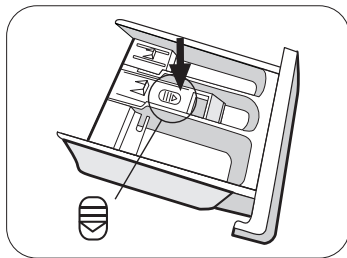

2. Clean the dispenser drawer and the softener cover under water

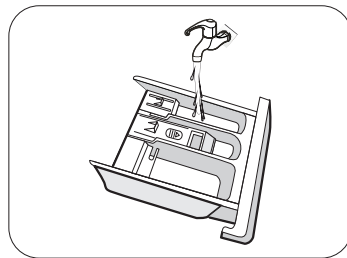

3. Clean the recess with a soft brush

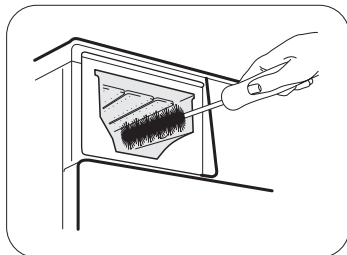

4. Insert the dispenser drawer back into place.

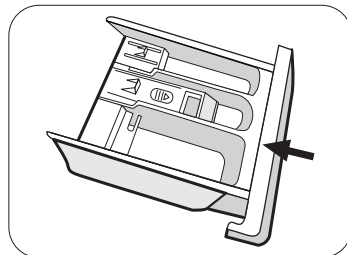

NOTE:

- Do not use abrasive or caustic agents to clean plastic parts.
- Clean the detergent dispenser every 3 months to ensure the normal operation of the appliance.

Cleaning the Drain Pump Filter

(Removing foreign objects)

WARNING:

- Make sure that the machine has finished the washing cycle and is empty. Switch it off and unplug it before cleaning the drain pump filter.
- Be careful of hot water. Wait for water cooling down. Risk of scalding!
- Clean the filter periodically every 3 months to ensure the normal operation of the appliance.

1. Open the Service Panel cover cap

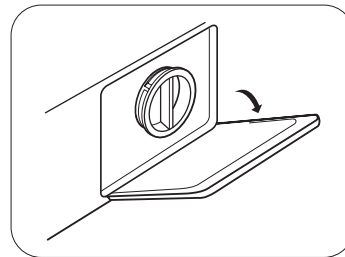

2. Open the filter by turning to the counter clockwise.

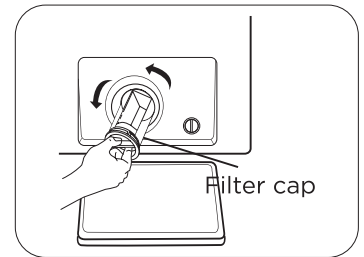

3. Remove any foreign objects matters.

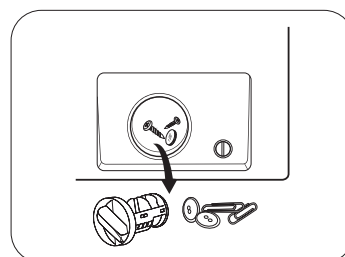

4. Carefully reinsert the filter and screw the lower cover cap in clockwise.

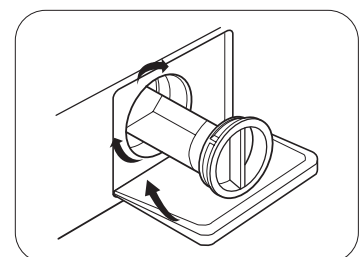

CAUTION:

- Make sure that filter cap is reinstalled properly, cap plates should be inserted aligning to hole plates otherwise water may leak.
- Rotate filter lower cover cap directly to make water run into a tray or basin.
- When the appliance is in use and depending on the programme selected there can be hot water in the pump. Never remove the pump cover during a wash cycle, always wait until the appliance has finished the cycle, and is empty. When replacing the cover, ensure it is securely re-tightened.

Troubleshooting

Whenever there is a problem with the appliance, check if you can solve it following the tables below. If the problem persists, please contact After Sales Support.

Description	Possible Cause	Solution
Appliance does not start	Door may not be closed properly. Clothes may be stuck.	Close the door properly and restart. Check for laundry.
Door can't be opened	Safety protection is activated.	Disconnect the power and restart.
Water leakage	Connections are not tight enough.	Check and fasten the water inlet pipe. Check and clean the outlet hose.
Detergent residues in the detergent dispenser	Detergent is damp and/or clotted.	Clean and wipe the detergent dispenser dry.
Indicator or display does not work	PC board or harness have connection problems.	Switch off the power and check if the mains plug is connected properly.
Abnormal noise or rattling.	Transport bolts are still in place. Floor is not solid or level.	Check if the transport bolts have been removed (see page 09). Make sure the appliance is installed on a solid and level floor.

Error Codes

Description	Possible Cause	Solution
E30	Door is not be closed properly.	Close the door properly and restart.
E10	Water injecting problem during wash cycle.	Check if the water pressure is high enough. Straighten the water pipe. Clean the inlet valve filter.
E21	Overtime water draining	Check the drain hose for blockage.
E12	Water overflow	Restart the appliance.

For other errors, restart the appliance. If problems still persists, please contact the After Sales Support.

Troubleshooting (Continued)

Operation in case of emergency

In the event of an emergency you should:

- Switch off all Combi Washer Dryer controls.
- Switch the Combi Washer Dryer off at the power outlet and immediately unplug.
- Call the Customer Service team on 1300 11 4357 or email support@residentiagroup.com.au

Some minor faults can be fixed by referring to the instructions given in this Troubleshooting section.

There is also a self-help section online at <https://support.residentiagroup.com.au>

IMPORTANT: If your appliance appears to be operating incorrectly, then you should disconnect it from your electrical supply and then contact After Sales Support.

WARNING: Do not attempt to repair the Combi Washer Dryer yourself.

Please note that if a technician is asked to attend whilst the product is under warranty and finds that the problem is not the result of an appliance fault, then you may be liable for the cost of the call out charge.

The appliance must be accessible for the engineer to perform any necessary repair.

If your appliance is installed in such a way that an engineer is concerned that damage will be caused to the appliance or your home, then they will not complete a repair.

Please refer to the conditions of that appear on the warranty card at the rear of this user manual.

Attach Your Receipt Here



Purchase Details

For future reference, please record the following information which can be found on the rating plate and the date of purchase which can be found on your sales invoice.

STORE DETAILS

Store Name			
Address			
Telephone		Purchase Date	

PRODUCT DETAILS

Model No.			
Serial No.*			

Warranty Information

WARRANTY TERMS AND CONDITIONS LAUNDRY

This document sets out the terms and conditions of the product warranties for Residentia Group Appliances. It is an important document. Please keep it with your proof of purchase documents in a safe place for future reference should you require service for your Appliance.

1. IN THIS WARRANTY

- (a) 'acceptable quality' as referred to in clause 10 of this warranty has the same meaning referred to in the ACL;
 - (b) 'ACL' means Trade Practices Amendment (Australian Consumer Law) Act (No.2) 2010;
 - (c) 'Appliance' means any Residentia Group product purchased by you accompanied by this document;
 - (d) 'ASR' means Residentia Group authorised service representative;
 - (e) 'Residentia Group' means Residentia Group Pty Ltd of 165 Barkly Ave, Burnley VIC 3121, ACN 600 546 656 in respect of Appliances purchased in Australia;
 - (f) 'major failure' as referred to in clause 10 of this warranty has the same meaning referred to in the ACL and includes a situation when an Appliance cannot be repaired or it is uneconomic for Residentia Group, at its discretion, to repair an Appliance during the Warranty Period;
 - (g) 'Warranty Period' means:
 - (i) where the Appliance is used for personal, domestic or household use (i.e. normal single family use) as set out in the instruction manual, the Appliance is warranted against manufacturing defects for 24 months, following the date of original purchase of the Appliance;
 - (h) 'you' means the purchaser of the Appliance not having purchased the Appliance for re-sale, and 'your' has a corresponding meaning.
2. This warranty only applies to Appliances purchased and used in Australia and is in addition to (and does not exclude, restrict, or modify in any way) any non-excludable statutory warranties in Australia.
 3. During the Warranty Period Residentia Group or its ASR will, at no extra charge if your Appliance is readily accessible for service, without special equipment and subject to these terms and conditions, repair or replace any parts which it considers to be defective. Residentia Group or its ASR may use remanufactured parts to repair your Appliance. You agree that any replaced Appliances or parts become the property of Residentia Group. This warranty does not apply to light globes, batteries, seals, filters or similar perishable parts.
 4. Parts and Appliances not supplied by Residentia Group are not covered by this warranty.

Warranty Information (Continued)

5. You will bear the cost of transportation, travel and delivery of the Appliance to and from Residentia Group or its ASR. If you reside outside of the service area, you will bear the cost of:
 - (a) travel of an authorised representative;
 - (b) transportation and delivery of the Appliance to and from Residentia Group or its ASR, in all instances, unless the Appliance is transported by Residentia Group or its ASR, the Appliance is transported at the owner's cost and risk while in transit to and from Residentia Group or its ASR.
6. Proof of purchase is required before you can make a claim under this warranty.
7. You may not make a claim under this warranty unless the defect claimed is due to faulty or defective parts or workmanship. Residentia Group is not liable in the following situations (which are not exhaustive):
 - (a) the Appliance is damaged by:
 - (i) accident
 - (ii) misuse or abuse, including failure to properly maintain or service
 - (iii) normal wear and tear
 - (iv) power surges, electrical storm damage or incorrect power supply
 - (v) incomplete or improper installation
 - (vi) incorrect, improper or inappropriate operation
 - (vii) insect or vermin infestation
 - (viii) failure to comply with any additional instructions supplied with the Appliance;
 - (b) the Appliance is modified without authority from Residentia Group in writing;
 - (c) the Appliance's serial number or warranty seal has been removed or defaced;
 - (d) the Appliance was serviced or repaired by anyone other than Residentia Group, an authorised repairer or ASR.
8. This warranty, the contract to which it relates and the relationship between you and Residentia Group are governed by the law applicable where the Appliance was purchased.
9. To the extent permitted by law, Residentia Group excludes all warranties and liabilities (other than as contained in this document) including liability for any loss or damage whether direct or indirect arising from your purchase, use or non use of the Appliance.
10. For Appliances and services provided by Residentia Group in Australia, the Appliances come with a guarantee by Residentia Group that cannot be excluded under the Australian Consumer Law. You are entitled to a replacement or refund for a major failure and for compensation for any other reasonably foreseeable loss or damage. You are also entitled to have the Appliance repaired or replaced if the Appliance fails to be of acceptable quality and the failure does not amount to a major failure. The benefits to you given by this warranty are in addition to your other rights and remedies under a law in relation to the Appliances or services to which the warranty relates.
11. At all times during the Warranty Period, Residentia Group shall, at its discretion, determine whether repair, replacement or refund will apply if an Appliance has a valid warranty claim applicable to it.
12. Missing parts are not covered by warranty. Residentia Group reserves the right to assess each request for missing parts in a case by case basis. Any parts that are not reported missing in the first week after purchase will not provide free of charge.
13. To enquire about claiming under this warranty, please follow these steps:
 - (a) carefully check the operating instructions, user manual and the terms of this warranty;
 - (b) have the model and serial number of the Appliance available;
 - (c) have the proof of purchase (e.g. an invoice) available;
 - (d) telephone the numbers shown below.
14. You accept that if you make a warranty claim, Residentia Group and its ASR may exchange information in relation to you, in order to enable Residentia Group to meet its obligations under this warranty.

IMPORTANT

Before calling for service, please ensure that the steps in point 13 have been followed.

CONTACT SERVICE

→ Please call 1300 11 HELP (4357)

The Australian Consumer Law requires the inclusion of the following statement with this warranty:

Our goods come with guarantees that cannot be excluded under the Australian Consumer Law. You are entitled to a replacement or refund for a major failure and for compensation for any other reasonably foreseeable loss or damage. You are also entitled to have the goods repaired or replaced if the goods fail to be of acceptable quality and the failure does not amount to a major failure.



EST. 1981

Designed to Enhance

omega

Omega is proudly owned in Australia
by Residentia Group Pty. Ltd.

@residentia.group
www.residentia.group