



omega

Instruction Manual

60cm 8 Function Double Oven

ODO684X

ODO684XTGG

Thank you for purchasing an Omega appliance

Tailored for the modern aesthetic and lifestyle of busy people, your new Omega Appliance will make a welcome addition to the family.

Omega caters to style-savvy customers who look for balance between stunning form and clever function. This means a combination of sleek, chic, sophisticated design yet effortless functionality. And we source from the best. The best craftsmanship. The best innovation. From the best international design-houses.

All brought together under an appliance that stands for design-led balance.

Please take the time to read through the following instruction manual to familiarise yourself with the installation, operation requirements and maintenance to ensure optimum performance.

Further Information

For important information about your Omega Appliance such as warranty registration, manuals, features, and specifications please visit omegaappliances.com.au (if you are in Australia) and omegaappliances.co.nz (if you are in New Zealand) or contact our Customer Care team on the below email or phone numbers.

Registering Your Warranty

For peace of mind you can register your warranty at omegaappliances.com.au. Further information on the Warranty can be found at the end of this manual.

Contact Us

Our customer service team is here to help you with any question or concern. Both teams are on call Monday to Friday 9.00am to 5.00pm and of course you can always send an email at your convenience.

Australia Contact Details

Monday to Friday 9.00am – 5.00pm
Email: support@residentiagroup.com.au
Phone: 1300 11 4357

New Zealand Contact Details

Monday to Friday 9.00am – 5.00pm
Email: customercare@monacocorp.co.nz
Phone: 09 415 6000

To stay up to date and find simple and easy recipes, follow us on our socials:

facebook.com/omegaappliances
instagram.com/omegaappliances_au

READ THE INSTRUCTION BOOKLET BEFORE INSTALLING AND USING THE APPLIANCE.

It is important that you retain these instructions, proof of purchase as well as other important documents about this product for future reference.

The manufacturer will not be responsible for any damage to property or to persons caused by incorrect installation or improper use of the appliance.

Due to continual product development, Omega reserves the right to alter specifications and appearances without notice.

Contents

Important Safety Warnings.....	4
Appliance Details.....	5
Electrical Connections.....	5
Installation Instructions.....	6-7
Operating Instructions	8-13
Replacing the Oven Lamp.....	14
Removing and Replacing the Oven Door	15
Disassembling the Oven Door	16
Fitting Oven Shelves.....	17
Cleaning.....	18
Troubleshooting	18
Warranty	19

Disposal Information

- Most of the packaging materials are recyclable. Please dispose of these materials through your local recycling depot or by placing them into appropriate collection containers.
- If you wish to discard this product, please contact your local authorities and ask for the correct method of disposal.

Important Safety Warnings

IMPORTANT: Read the assembly instructions and safety precautions of this booklet carefully before removing the contents of the carton.

1. This appliance is not intended for use by persons (including children) with reduced physical, sensory or mental capabilities, or lack of experience or knowledge, unless they have been given supervision or instruction concerning the use of the appliance by a person responsible for their safety. Children should be supervised to ensure that they do not play with the appliance.
2. In certain circumstances electrical appliances may be a danger hazard.
3. Do not place heavy objects in or on these appliances, or use for storage, or let children play or swing from the door. These appliances are designed for cooking food only.
4. This appliance is designed for domestic household use only and for the cooking of domestic food products. Use as a commercial appliance will void the warranty. It should not be used in a marine environment or outdoors.
5. If the electrical supply cord is damaged, either when being installed or after installation, it must be replaced by the manufacturer, its service center or similarly qualified persons in order to prevent a hazard.
6. The electrical connection must be accessible after installation. The appliance must be electrically isolated before any maintenance can be performed, which includes changing a lamp.
7. Electrical connection must be made as per local wiring rules and regulations. Do not disconnect the appliance with wet hands or bare feet, and do not disconnect the power cord with extreme force.
8. Always grasp the oven door in the center of the handle as the areas around the door edges may be hot due to the escape of hot air.
9. Ensure that the kitchen is well ventilated or mechanical ventilation is in use while cooking in this appliance.
10. Do not store or use flammable materials or aerosols near the oven. Items made from aluminium, plastic or plastic film should also be kept away from the appliance, as they may fuse to the surface.
11. Never line the oven bottom with aluminium foil, as the consequent accumulation of heat could compromise the cooking and even damage the enamel.
12. **WARNING** - The oven will become hot during and directly after use. Do not touch any components during this time, as they may be hot and can cause burns. Do not touch the heating elements inside the oven to avoid burns. Young children should be kept away. Use heat resistant cooking gloves where-ever possible when moving food and cooking utensils in and out of the oven.
13. Cleaning may only be commenced on the appliance once it has cooled down (best slightly warm). The appliance should be disconnected from the power outlet or turned off at your isolation switch before commencing any cleaning process. Do not use a steam jet or any other high pressure cleaning equipment to clean the appliance. Follow oven cleaner directions if these are being used.
14. Wash all accessories in hot soapy water or in a dishwasher, wipe dry with a paper or cloth towel. If you use your oven for an extended period of time, condensation may form. Dry it using a soft dry cloth.
15. When the appliance is not being used, the knobs must be kept in the 'OFF' position.
16. Where this appliance is installed in a caravan, it shall NOT be used as a space heater.
17. Do not modify this appliance.
18. Do not use harsh abrasive cleaners or sharp metal scrapers to clean the oven door glass as it can scratch the surface, which may result in the glass shattering. Clean the glass door using warm damp cloth and dry it with a soft cloth.
19. All cabinetry and materials used in the installation must be able to withstand a minimum temperature of 50°C above the ambient temperature of the room it is located in, whilst in use. Certain types of vinyl or laminate kitchen furniture are particularly prone to heat damage or discolouration at temperatures outside the guidelines given above. Any damage caused by the appliance being installed without adhering to the temperature limits set out above will be the liability of the owner.
20. This appliance must be correctly installed by a suitably qualified person, strictly in accordance with the manufacturer's instructions. Please see the specific section of this booklet that refers to installation.
21. The appliance must be installed and put in operation by an authorized technician under the conditions provided by the manufacturer in this manual. The manufacturer cannot be held responsible for any damage that might occur due to faulty installation.
22. The values indicated on the printed documents found on the product are values obtained in laboratory environment according to relevant standards. These values may vary according to the usage and environment conditions of product.
23. **WARNING** – Ensure that the appliance is switch off before replacing the lamp to avoid the possibility of electric shock.



DO NOT OPERATE THIS APPLIANCE BEFORE READING THE INSTRUCTION BOOKLET
DO NOT PLACE ARTICLES ON OR AGAINST THIS APPLIANCE
DO NOT STORE CHEMICALS OR FLAMMABLE MATERIALS OR SPRAY AEROSOLS NEAR THIS APPLIANCE

Appliance Details

Electrical Details

Model	ODO684X
Rated Voltage	220-240V ~50Hz
Rated Power Input	4360-5190W

Dimensions

DEPTH (mm)	WIDTH (mm)	HEIGHT (mm)
546	595	888

Electrical Connections



LOCAL AUTHORITY REQUIREMENTS

Installation is only permitted by a licensed electrician, and carried out according to instructions provided by the manufacturer. Incorrect installation might cause harm and damage which the manufacturer accepts no responsibility.

ELECTRICAL INSTALLATION FOR THE LICENSED ELECTRICIAN

This oven must be connected to a 220-240V 50Hz power supply. It is earthed via the cord. Before carrying out the connection to the power supply, the voltage rating of the appliance (stamped on the appliance identification plate) must be checked for correspondence to the available mains supply voltage, and the mains electric wiring should be suitable for the oven's power rating (also indicated on the appliance identification plate);

The switched outlet must be connected to a suitable earth wiring, in conformity to current safety regulations. It should not be located above the appliance and no more than 1.25m away from it. The power supply cord must not touch against any hot surfaces and must be placed so that its temperature does not exceed 75°C at any point along its length. Means for disconnection must be incorporated in the fixed wiring in accordance with the wiring rules.

After having installed the appliance, the switched outlet must always be in an accessible position.

NOTE: For connections to the mains power supply, never use adapters, reductions or multiple power points as these may overheat and catch fire. A circuit breaker with a contact opening of at least 3mm must be installed inside the supply circuit.

The mains terminal block is located on the back of the oven and the terminals are accessible by opening the terminal block cover.

NOTE: The terminal cover should not be opened when the mains power is still connected to the appliance and never by an unauthorized person.

The electrical safety of this appliance can only be guaranteed if the oven is correctly and efficiently earthed. The manufacturer declines all responsibility for damage resulting from an installation which has not been earthed correctly.

Installation Instructions



The adjacent furniture must be able to withstand a minimum temperature rise of 100°C above the ambient temperature of the room it is located in, during periods of use. The power supply to the appliance must be cut off before any adjustments or maintenance work is done on it.

PREPARATION FOR INSTALLATION AND USE

Manufactured with best quality parts and materials, this modern, functional and practical oven will meet your needs in all respects. Make sure to read the manual to obtain successful results so as not to experience any problems in the future. The information given below contains rules that are necessary for correct positioning and service operations. They should be read without fail, especially by the technician who will position the appliance.

CHOOSING A PLACE FOR THE APPLIANCES

There are several points to pay attention to when choosing a place for your oven. Make sure to take into account our recommendations below in order to prevent any problems and dangerous situations, which might occur later!

When choosing a place for the oven, attention should be paid that there are no flammable or combustible materials in the close vicinity, such as curtains, oil, cloth etc. which quickly catch fire.

Furniture surrounding the oven or cooktop must be made of materials resistant to temperatures above 100 C°. Required changes to wall cabinets and exhaust fans above a built-in cooktop as well as minimum heights from the oven board are shown in Figure 1. Accordingly, the exhaust fan should be at a minimum height of 65 cm from the cooktop. If there is no exhaust fan the height should not be less than 70 cm.

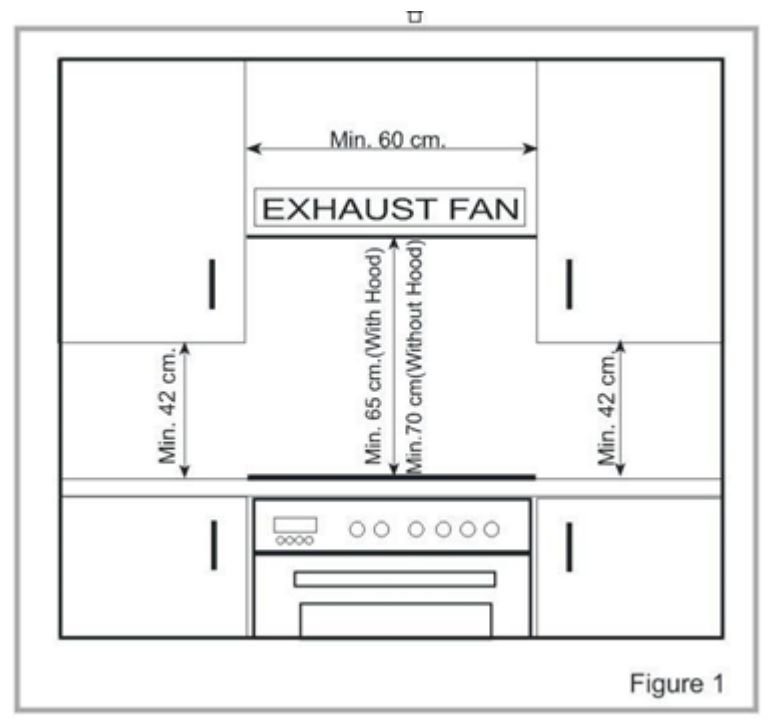

Note: The appliance must not be installed behind a decorative door in order to avoid overheating.

Installation Instructions

Insert the oven into cabinet partly by pushing it forward. Open the oven door and insert 2 screws into the holes on the oven frame. While the product frame touches the wooden surface of the cabinet, tighten the screws. If installed under a cooktop, there must be at least 50mm between the two appliances, and the distance between the worktop and the top of the control panel must be a minimum of 25mm.

The dimensions and material of the cabinet in which the oven will be installed must be correct and resistant to increases in temperature. In a correct installation, contact with electrical or insulated parts must be prevented. Insulating parts need to be fitted in a way to ensure that they cannot be removed by using any kind of tool.

Installing the appliance in the close vicinity of a refrigerator or a deep-freezer is not recommended as the performance of the above-mentioned appliances will be negatively affected due to emanating heat. After removing your oven from its packaging, be sure that the oven is not damaged. If you suspect any damage to the appliance, do not use it; immediately contact an authorized Service Centre.

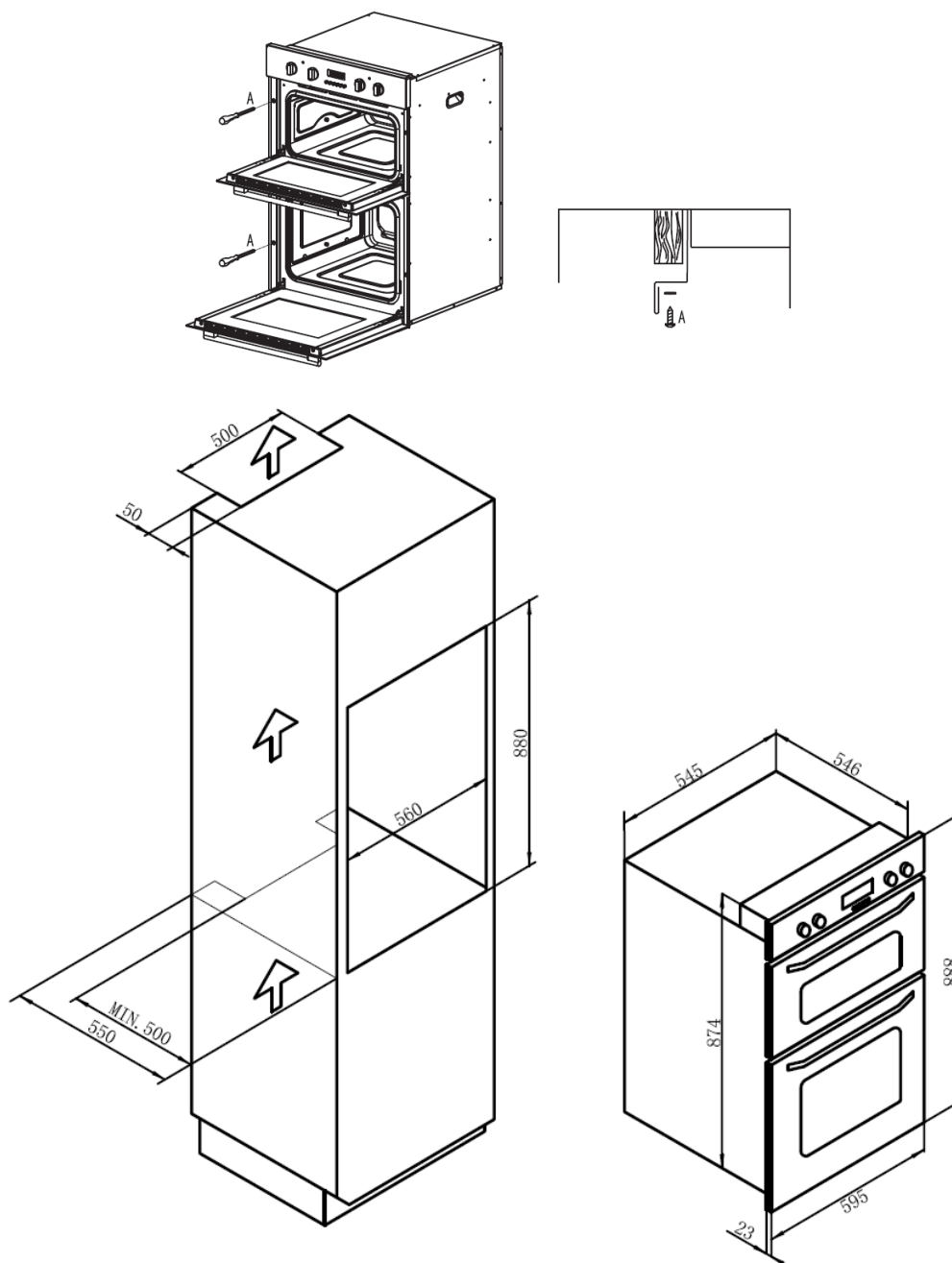

Operating Instructions

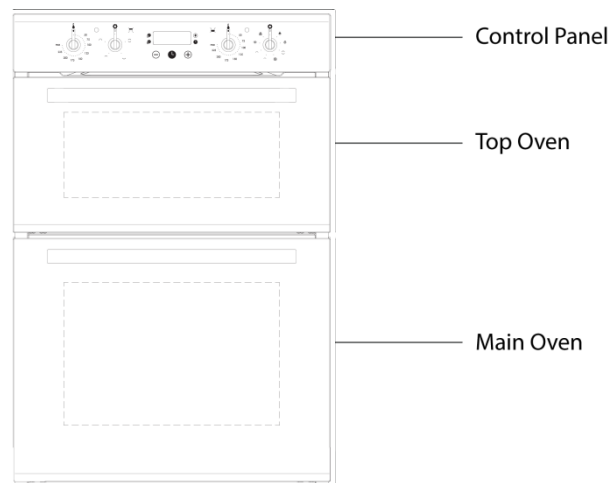

When you first run your oven a certain smell will be emanated arising from the insulation materials and the heater elements. For this reason, before using your oven, run it empty at maximum temperature for 45 minutes. At the same time you need to properly ventilate the environment in which the oven is installed. In order to cook in your oven, the oven function and temperature setting controls need to be adjusted and the oven timer, if available, needs to be programmed. Otherwise, the oven will not operate. Unplug your appliance when it is not in use. Protect your appliance from atmospheric effects. Do not leave it under the effects of the sun, rain, snow, dust etc.

Controls

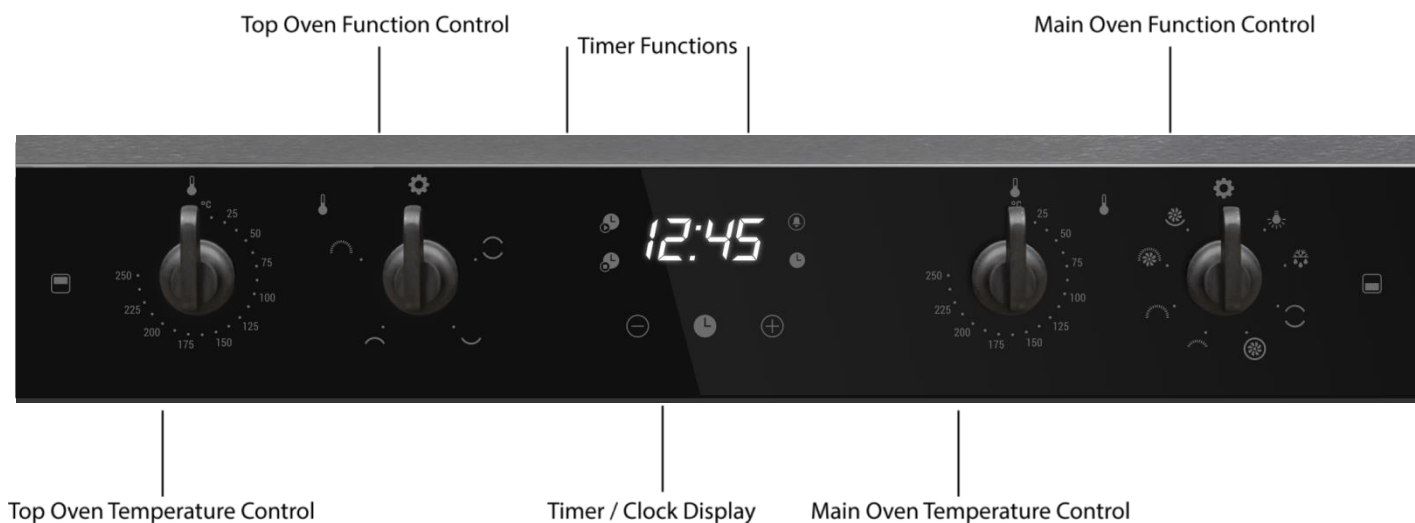

Top Oven Function Control: Use to set the cooking function for the top oven.

Top Oven Temperature Control: Use to set the desired temperature for cooking with the top oven.

Main Oven Function Control: Use to set the cooking function for the main oven.

Main Oven Temperature Control: Use to set the desired temperature for cooking with the main oven.

Timer Functions: Allows the oven to display clock, timer and oven temperature.

Operating Instructions

Top Oven Functions



Conventional

Both the lower and upper heating elements operate together. This is the traditional cooking method.



Bottom Heating Element

This function is particularly indicated for cooking from the bottom, warming up food or sterilizing glass jars. It is also recommended for foods requiring long and slow cooking, i.e. casseroles. This function can be used between 50 and 250°C.



Top Heating Element

It is indicated for warming up pre-cooked food when placing the grid on the second shelf from the top, or for defrosting pastry placing the grid on the first shelf from the bottom. This function can be used between 50 and 250°C.



Maxi Grill

It is indicated for grilling and gravitating traditional food.

Main Oven Function Controls



Internal Oven Light



Fan Defrost

The air at ambient temperature is distributed inside the oven for defrosting food more quickly and without proteins adulteration.



Conventional

A conventional oven works on the principle that heat rises. It is hotter at the top than at the bottom - ideal for cooking meat in different side simultaneously.



Fan Forced

Both the fan and the circular heating element operate together. The hot air adjustable between 50 and MAX°C is evenly distributed inside the oven. This is ideal for cooking several types of food (meat, fish) at the same time without affecting taste and smell. It is indicated for delicate pastries.

Operating Instructions

Main Oven Function Controls



Grill

It is indicated for grilling and gravitating small quantities of traditional food.



Maxi Grill

Function for grilling foods.

Fan Forced Maxi Grill



Important: do not set thermostat knob (C) to over 175°C. During grilling, keep the oven door closed. All grill components and fan work. In this setting, the central heating elements of the top work. This combination of features compulsory in the air in the oven for the entire cycle of increased non-direct heating elements heat radiation effect. This will allow the heat to penetrate the internal food, and avoid burning of the food.



Bottom heating Element with Fan

The air which is heated by the lower heating element is circulated by the fan and so helps to distribute the heat between 50 and 200°C. This function can be used for sterilizing glass jars.



Accessories

It is recommended that you use the containers indicated depending on the food you will cook in your oven. You can also use glass containers, cake pans and special oven trays suitable for use in your oven (available in kitchenware shops). Pay attention to the information given by the supplier for use of this cookware. The information given below should be implemented for enameled containers.

If the food to be cooked does not completely cover the oven tray, if the food is taken out of the deep-freezer or if the tray is used to collect the dripping juices of the foods during the grill operation, deformation might be observed on the tray over time due to high temperatures forming during the cooking/baking operation. This is a normal, physical state that results during the heat transfer. Do not leave a glass tray or container in a cold environment immediately after cooking in them. Do not place them on cold and wet surfaces. ensure that they slowly cool off by placing them on a dry piece of cloth or wooden board, otherwise, the glass tray or container might break. If you are going to use the large wire oven rack/grill, insert a tray into one of the lower racks to collect fat or oil. To make cleaning easier, add some water into this tray. In a grilling operation, use the shelf in position 4 or 5.

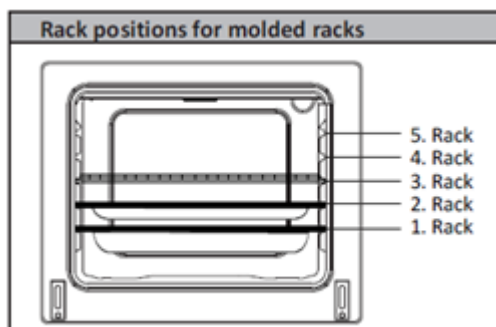
Each wire grid and tray comes with a built-in safety feature to help minimize them being accidentally pulled fully out. This comes in the way of a "step", positioned part-way in from the rear of the accessory. To fit them into the oven, push the wire grid or tray part way into the oven until the step "catches", then angle the part over the step & fully insert. To remove, repeat the operation in reverse.

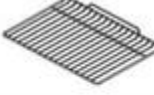

Wire grid	
	Wire grid is used to grill or to place different cookwares on it. To locate the wire grid correctly in the cavity, put it to any rack and push it up to the end.
Deep Tray	
	Deep tray is used to cook stews. To locate the tray correctly in the cavity, put it to any rack and push it up to the end.

Operating Instructions

Timer Operation

Features:

24 hours clock with automatic programmer and minute minder. Timer is only for main oven.

Functions:





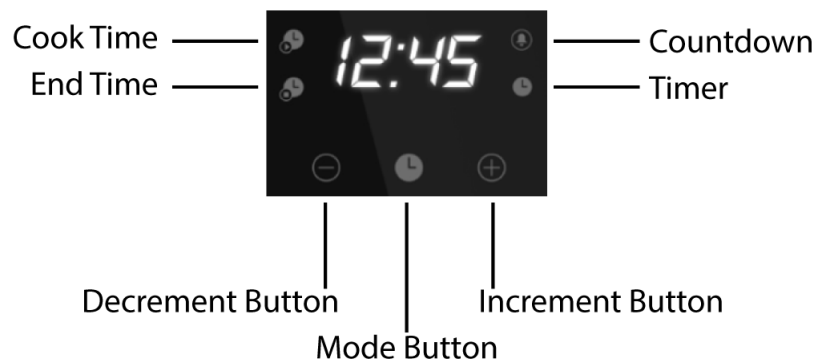

Minute minder, Cooking time, cooking end time, and Time of day.

Setting:





There are 3 buttons on the timer, “-”, “Mode”, and “+”. The Mode button is used to select the required timer function & the other two are used to decrease or increase a value. Press the + or – keys once to change a value by 1, or hold down to change faster.



Electronic Timer Setting:

This oven only operates when the time has been set. When the appliance has been connected to the electrical supply or when there has been a power cut, the function indicator Timer  flashes automatically. To change the time that has been set, press the selection button  repeatedly until the function indicator Time  flashes. Set the current time using the  or  buttons. The appliance is now ready to use. The time can only be changed if neither of the automatic functions (Cook time  or End time ) has been set.

Clock Functions

-  **Countdown**
To set a countdown, a signal will sound after the time has elapsed. This function does not affect the operation of the oven.
-  **Cook time**
To set how long the oven is to be in use.
-  **End Time**
To set when the oven is automatically switched off.
-  **Time**
To set, change or check the time.



Operating Instructions

How to use the Clock Functions

When a function has been selected, the corresponding function indicator flashes for 5 seconds. During this time, the desired times can be set using the \oplus or \ominus buttons.



Once the desired time has been set, the function indicator flashes for another 5 seconds. After that the function indicator is then lit. The set time begins to run.

Press any of the buttons to stop the acoustic signal.

The desired oven function and temperature can be selected before or after the clock functions of Cook Time  and End Time  are set.

When the cooking time has ended, turn the oven function and temperature control knobs back to the off position.



Countdown

Press the selection button  repeatedly, until the countdown indicator function  flashes. Using the \oplus or \ominus buttons, set the required countdown time (Max 23h 59m). After 5 seconds, the display shows the remaining time. The function indicator countdown  flashes and an acoustic signal will sound.

Press and button the switch off the alarm.

To adjust the countdown setting, press the selector button until the countdown function indicator flashes. The countdown can now be adjusted using the \oplus or \ominus buttons.



Cook Time

Press the selection button  repeatedly, until the function indicator Cook Time  flashes. Using the \oplus and \ominus buttons, set the required cooking time.

After 5 seconds, the display will return to the current time. The function indicator Cook Time  will light up.





When the time has elapsed, the function indicator will flash, an acoustic alarm will sound for 2 minutes and the oven will automatically switch off. Turn the temperature control and oven function control knobs off.

Press any button to switch off the alarm.

To check or adjust the cook time, press the selection button  repeatedly until the cook time function indicator  is flashing. The display will show the current setting. Adjust the time using the \oplus and \ominus buttons.



Operating Instructions

End Time

Press the selection button  repeatedly until the function indicator End Time  flashes. The display will show the current time. Use the  and  buttons to set the required end time.



After 5 seconds, the display will return to the current time. The function indicator end time  will light up. When the time has been reached, the function indicator will flash, an alarm will sound for 2 minutes and the oven will automatically switch itself off. Turn the function control and temperature control knobs off. Press any button to switch off the alarm.

Cook Time and End Time Combined

Cook Time  and End Time  can be used simultaneously if the oven is to be automatically switched on and off at a later time.

Using the function Cook Time , set the period of time that the dish requires to cook.

Using the function End Time , set the time at which the dish is required to be ready.

The function indicators Cook Time  and End Time  will light up and the time will be shown on the display. The oven will automatically switch itself on when the current time reaches the cook time, and will automatically switch itself off when the current time reaches the end time. Turn the oven function and temperature control knobs off when finished. Press any button to switch off the alarm.

Replacing the Oven Lamp

- The appliance must first be disconnected from the power outlet or turned off at your isolation switch.
- Unscrew the glass cover attached to the lamp holder; anti-clockwise.
- Unscrew the lamp and replace it with another high-temperature lamp with the following characteristics:

Type	E14
Voltage Rating	220-240V AC
Power Rating	25W
Temperature Rating	300°C

- Remount the glass cover and reconnect the appliance to the power supply.

NOTE: Should you experience any difficulty please contact your nearest after-sales service center.

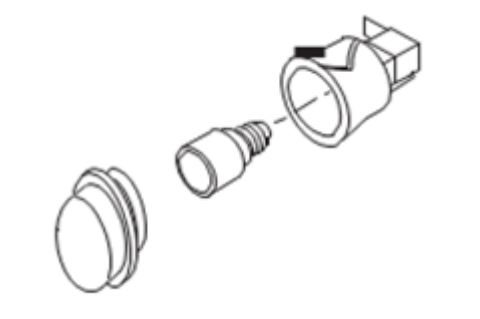

Removing and Replacing the Oven Door

Removing the Oven Door

To make it easier to clean the inside of the oven, the oven door can be removed, by proceeding as follows:

- Open the door completely and lift the 2 levers “B” (figure1)
- Now, shutting the door slightly, you can lift it out by pulling out the hooks “A” as shown in figure 2.

Replacing the Oven Door

- With the door in vertical position insert the two hooks “A” into the slots
- Ensure that seat “D” is hooked perfectly onto the edge of the slot (move the oven door backwards and forwards slightly)
- Keep the oven door open fully, unhook the 2 levers “B” downwards and then shut the door again.

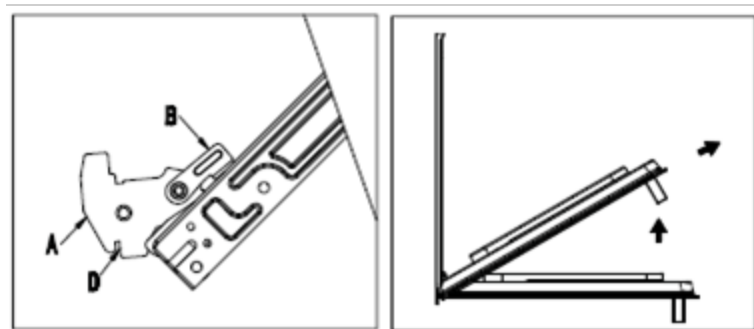

Fig. 1

Fig. 2

Disassembling the Oven Door

The oven door is made up of 3 panes of glass and has vents at the top and bottom. When the oven is operating, air is circulated through the door to keep the outer pane cool. If condensation has worked its way in between the glass panes, the door can be dismantled in order to clean in between the panes. Remove the door as per above instruction and place it on a protective surface (e.g. on a table cloth) to prevent it being scratched. The door handle should line up with the edge of the table. Make sure the glass lies flat to avoid the breakage of glass during cleaning.

To remove:

1. Undo the 2 screws on upper bracket
2. Take out the upper bracket and first pane of glass
3. Loosen the 4 clips
4. Slide out middle pane of glass carefully. Clean the glass panes and other parts with a damp microfiber cloth or sponge and a solution of hot water with a little washing-up liquid. Wipe dry using a soft cloth.

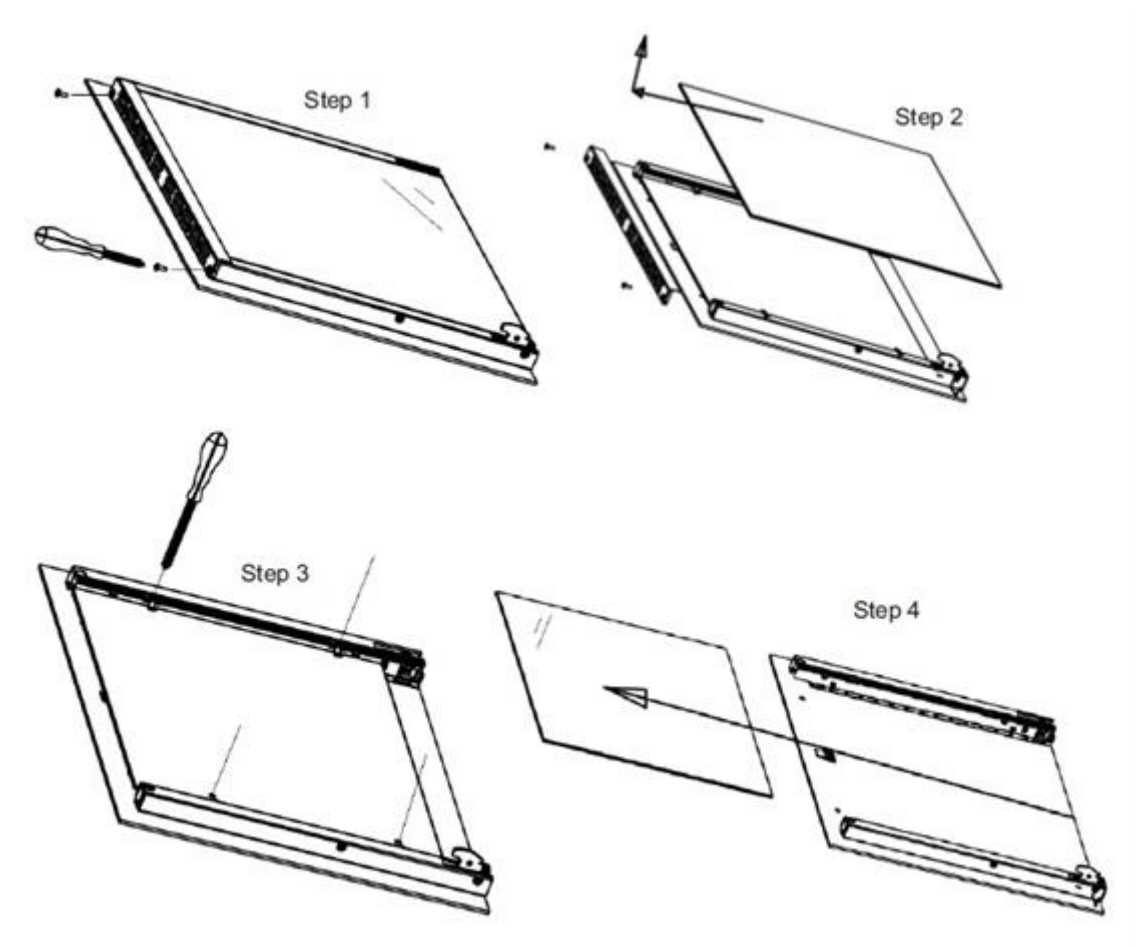

Fitting Oven Shelves

1. Ensure shelf orientation is correct
2. Slide into oven at an angle until raised back of shelf is past the stop on side runners
3. Lower front of shelf and push in until stop is reached
4. To remove oven shelves withdraw to the stop and raise the front of shelf to clear the stop.

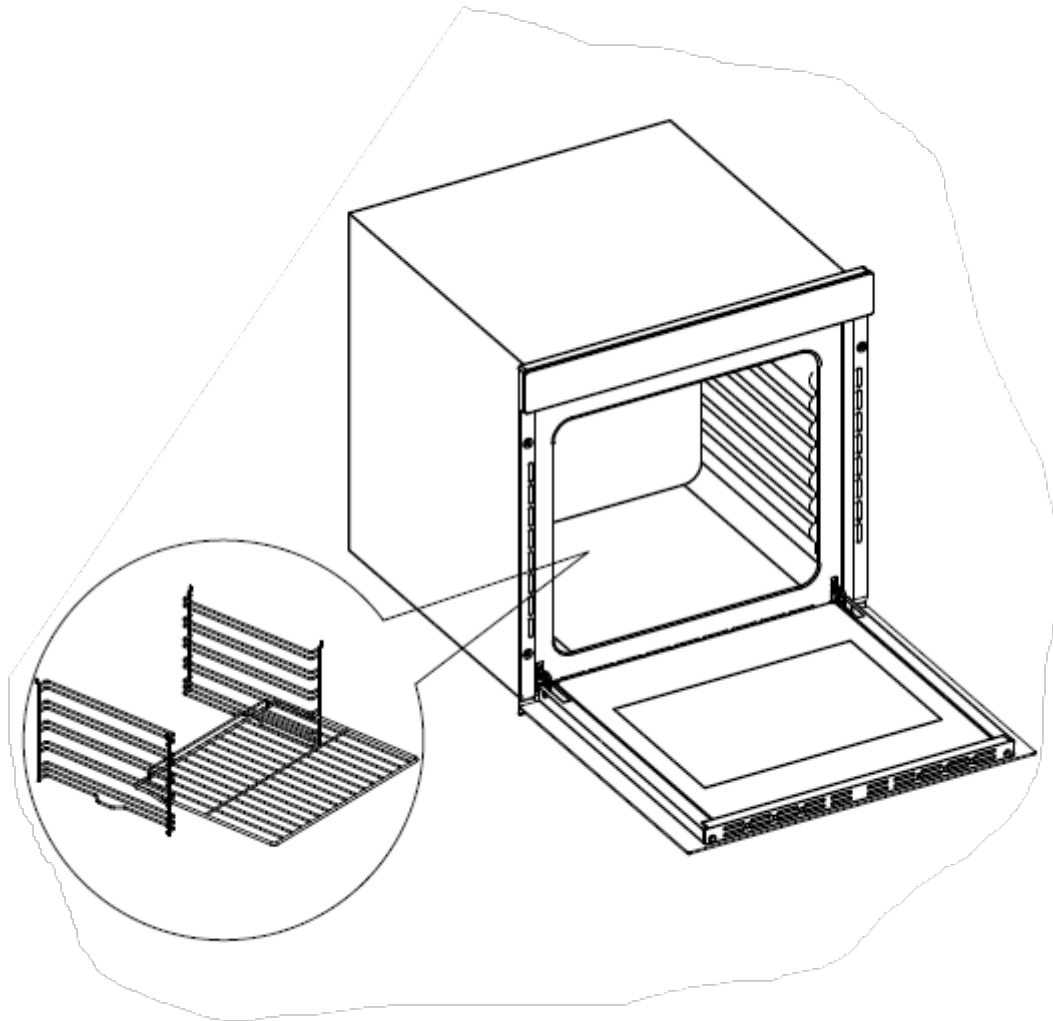

Cleaning



NOTE: Cleaning and maintenance operations must only be carried out when the oven is cool.

The appliance should be disconnected from the power outlet or turned off at your isolation switch before commencing any cleaning process.

Cleaning the oven exterior:

Before starting to clean your oven, be sure that all control buttons are off and your appliance has cooled off. Unplug the appliance.

Do not use cleaning materials containing particles that might scratch the enameled and painted parts of your oven. Use cream cleaners or liquid cleaners, which do not contain particles. As these cleaners may damage the surfaces, do not use caustic creams, abrasive cleaning powders, rough wire wool or hard tools. In the event of any excess liquids spilling over your oven surface during cleaning, clean up immediately so as to prevent possible damage to the enamel or metal surface. Do not use steam cleaners for cleaning the oven.

Cleaning the interior of the oven:

Make sure to unplug the oven before starting to clean it. You will obtain best results if you clean the oven interior while the oven is slightly warm (the oven should not be operating). Wipe your oven with a soft piece of cloth (e.g. dish cloth) dampened with warm soapy water after each use, rinse cloth in warm water then wipe oven again and then finish by wiping with a dry cloth. For a complete cleaning process, use dry and powder type oven cleaners, following the oven cleaning product's instructions.

Troubleshooting

If the oven does not operate:

- The oven may be unplugged from the power source or switched off at the power source.
- The household fuse has blown or household power supply is off.
- The Timer (if available) may not have been set correctly.

If the oven does not heat:

- The heat may not be set correctly with the oven's temperature setting.

If the interior lighting lamp does not light:

- The lamps are defective. If they are defective, you can change them following the instructions within this manual.

Cooking (if lower-upper part does not cook equally):

- Control the shelf locations, cooking period and heat values according to the manual.

Unit smoking when first used:

- This is a result of protective oils being removed and is to be expected with a first use.

Oven fan is still running even though knobs in off position:

- The cooling fan has activated to cool down the control; this is normal and may stay on for some time.

Clock Flashing on Display

- Power failure or interruption

If you have any further problems with your product, please call your Authorized Service Centre.

Warranty

WARRANTY TERMS AND CONDITIONS OVENS

This document sets out the terms and conditions of the product warranties for Residentia Group Appliances. It is an important document. Please keep it with your proof of purchase documents in a safe place for future reference should you require service for your Appliance.

1. IN THIS WARRANTY

- (a) 'acceptable quality' as referred to in clause 10 of this warranty has the same meaning referred to in the ACL;
 - (b) 'ACL' means Trade Practices Amendment (Australian Consumer Law) Act (No.2) 2010;
 - (c) 'Appliance' means any Residentia Group product purchased by you accompanied by this document;
 - (d) 'ASR' means Residentia Group authorised service representative;
 - (e) 'Residentia Group' means Residentia Group Pty Ltd of 165 Barkly Ave, Burnley VIC 3121, ACN 600 546 656 in respect of Appliances purchased in Australia;
 - (f) 'major failure' as referred to in clause 10 of this warranty has the same meaning referred to in the ACL and includes a situation when an Appliance cannot be repaired or it is uneconomic for Residentia Group, at its discretion, to repair an Appliance during the Warranty Period;
 - (g) 'Warranty Period' means:
 - (i) where the Appliance is used for personal, domestic or household use (i.e. normal single family use) as set out in the instruction manual, the Appliance is warranted against manufacturing defects for 24 months, following the date of original purchase of the Appliance;
 - (h) 'you' means the purchaser of the Appliance not having purchased the Appliance for re-sale, and 'your' has a corresponding meaning.
2. This warranty only applies to Appliances purchased and used in Australia and is in addition to (and does not exclude, restrict, or modify in any way) any non-excludable statutory warranties in Australia.

3. During the Warranty Period Residentia Group or its ASR will, at no extra charge if your Appliance is readily accessible for service, without special equipment and subject to these terms and conditions, repair or replace any parts which it considers to be defective. Residentia Group or its ASR may use remanufactured parts to repair your Appliance. You agree that any replaced Appliances or parts become the property of Residentia Group. This warranty does not apply to light globes, batteries, filters, seals or similar perishable parts.
4. Parts and Appliances not supplied by Residentia Group are not covered by this warranty.
5. You will bear the cost of transportation, travel and delivery of the Appliance to and from Residentia Group or its ASR. If you reside outside of the service area, you will bear the cost of:
 - (a) travel of an authorised representative;
 - (b) transportation and delivery of the Appliance to and from Residentia Group or its ASR, in all instances, unless the Appliance is transported by Residentia Group or its ASR, the Appliance is transported at the owner's cost and risk while in transit to and from Residentia Group or its ASR.
6. Proof of purchase is required before you can make a claim under this warranty.
7. You may not make a claim under this warranty unless the defect claimed is due to faulty or defective parts or workmanship. Residentia Group is not liable in the following situations (which are not exhaustive):
 - (a) the Appliance is damaged by:
 - (i) accident
 - (ii) misuse or abuse, including failure to properly maintain or service
 - (iii) normal wear and tear
 - (iv) power surges, electrical storm damage or incorrect power supply
 - (v) incomplete or improper installation
 - (vi) incorrect, improper or inappropriate operation
 - (vii) insect or vermin infestation
 - (viii) failure to comply with any additional instructions supplied with the Appliance;

— THIS WARRANTY IS VALID IN AUSTRALIA ONLY —

Warranty

- (b) the Appliance is modified without authority from Residentia Group in writing;
 - (c) the Appliance's serial number or warranty seal has been removed or defaced;
 - (d) the Appliance was serviced or repaired by anyone other than Residentia Group, an authorised repairer or ASR.
8. This warranty, the contract to which it relates and the relationship between you and Residentia Group are governed by the law applicable where the Appliance was purchased.
9. To the extent permitted by law, Residentia Group excludes all warranties and liabilities (other than as contained in this document) including liability for any loss or damage whether direct or indirect arising from your purchase, use or non use of the Appliance.
10. For Appliances and services provided by Residentia Group in Australia, the Appliances come with a guarantee by Residentia Group that cannot be excluded under the Australian Consumer Law. You are entitled to a replacement or refund for a major failure and for compensation for any other reasonably foreseeable loss or damage. You are also entitled to have the Appliance repaired or replaced if the Appliance fails to be of acceptable quality and the failure does not amount to a major failure. The benefits to you given by this warranty are in addition to your other rights and remedies under a law in relation to the Appliances or services to which the warranty relates.
11. At all times during the Warranty Period, Residentia Group shall, at its discretion, determine whether repair, replacement or refund will apply if an Appliance has a valid warranty claim applicable to it.
12. Missing parts are not covered by warranty. Residentia Group reserves the right to assess each request for missing parts in a case by case basis. Any parts that are not reported missing in the first week after purchase will not provide free of charge.
13. To enquire about claiming under this warranty, please follow these steps:
- (a) carefully check the operating instructions, user manual and the terms of this warranty;
 - (b) have the model and serial number of the Appliance available;
 - (c) have the proof of purchase (e.g. an invoice) available;
 - (d) telephone the numbers shown below.
14. You accept that if you make a warranty claim, Residentia Group and its ASR may exchange information in relation to you to enable Residentia Group to meet its obligations under this warranty.

IMPORTANT

Before calling for service, please ensure that the steps in point 13 have been followed.

CONTACT SERVICE

→ Service: 1300 11 HELP (4357)

The Australian Consumer Law requires the inclusion of the following statement with this warranty:

Our goods come with guarantees that cannot be excluded under the Australian Consumer Law. You are entitled to a replacement or refund for a major failure and for compensation for any other reasonably foreseeable loss or damage. You are also entitled to have the goods repaired or replaced if the goods fail to be of acceptable quality and the failure does not amount to a major failure.

— THIS WARRANTY IS VALID IN AUSTRALIA ONLY —

