

The logo features the word "omega" in a bold, lowercase, sans-serif font. The letter "o" is distinguished by a horizontal line passing through its center. The text is positioned within a large, light gray circular graphic that is partially cut off by the right edge of the page.

omega

Instruction Manual

OMEGA OVEN

OBO696XB

Thank you for purchasing an Omega appliance

Tailored for the modern aesthetic and lifestyle of busy people, your new Omega Appliance will make a welcome addition to the family.

Omega caters to style-savvy customers who look for balance between stunning form and clever function. This means a combination of sleek, chic, sophisticated design yet effortless functionality. And we source from the best. The best craftsmanship. The best innovation. From the best international design-houses.

All brought together under an appliance that stands for design-led balance.

Please take the time to read through the following instruction manual to familiarise yourself with the installation, operation requirements and maintenance to ensure optimum performance.

Further Information

For important information about your Omega Appliance such as warranty registration, manuals, features, and specifications please visit omegaappliances.com.au (if you are in Australia) and omegaappliances.co.nz (if you are in New Zealand) or contact our Customer Care team on the below email or phone numbers.

Registering Your Warranty

For peace of mind you can register your warranty at omegaappliances.com.au. Further information on the Warranty can be found at the end of this manual.

Contact Us

Our customer service team is here to help you with any question or concern. They are on call Monday to Friday 8.30am to 5.00pm and of course you can always send a email at your convenience.

Email: customercare@omegaappliances.com.au

Phone: 1300 739 033

To stay up to date and find simple and easy recipes, follow us on our socials:

facebook.com/omegaappliances

instagram.com/omegaappliances_au

READ THE INSTRUCTION BOOKLET BEFORE INSTALLING AND USING THE APPLIANCE.

It is important that you retain these instructions, proof of purchase as well as other important documents about this product for future reference.

The manufacturer will not be responsible for any damage to property or to persons caused by incorrect installation or improper use of the appliance.

Due to continual product development, Omega reserves the right to alter specifications and appearances without notice.

Contents

Important Safety Warnings	1
Appliance Details.....	2
Electrical Connections	2
Installation Instructions.....	3-5
Operating Instructions	6-13
Accessories	14
Replacing the Oven Lamp.....	15
Cleaning.....	16
Troubleshooting	16
Australian & New Zealand Product Warranty Statements of Standard Warranty Conditions	17

Disposal Information

- Most of the packaging materials are recyclable. Please dispose of these materials through your local recycling depot or by placing them into appropriate collection containers.
- If you wish to discard this product, please contact your local authorities and ask for the correct method of disposal.

Important Safety Warnings

IMPORTANT: Read the assembly instruction section and safety precautions of this booklet carefully before removing the contents of this carton.

1. This appliance is not intended for use by persons (including children) with reduced physical, sensory or mental capabilities, or lack of experience or knowledge, unless they have been given supervision or instruction concerning the use of the appliance by a person responsible for their safety. Children should be supervised to ensure that they do not play with the appliance.
2. In certain circumstances electrical appliances may be a danger hazard.
3. Do not place heavy objects in or on these appliances, or use for storage, or let children play or swing from the door. These appliances are designed for cooking food only.
4. This appliance is designed for domestic household use only and for the cooking of domestic food products. Use as a commercial appliance will void the warranty. It should not be used in a marine environment or outdoors.
5. The ovens are supplied with a set of cables for single phase connection. This is a high-powered appliance and is required to be installed by an authorised person.
6. If the electrical supply cord is damaged, either when being installed or after installation, it must be replaced by the manufacturer, its service centre or similarly qualified persons in order to prevent a hazard.
7. The electrical connection must be accessible after installation. The appliance must be electrically isolated before any maintenance can be performed, which includes changing a lamp.
8. Electrical connection must be made as per local wiring rules and regulations. Do not disconnect the appliance with wet hands or bare feet, and do not disconnect the power cord with extreme force.
9. Always grasp the oven door in the centre of the handle as the areas around the door edges may be hot due to the escape of hot air.
10. Ensure that the kitchen is well ventilated or mechanical ventilation is in use while cooking in this appliance.
11. Do not store or use flammable materials or aerosols near the oven. Items made from aluminium, plastic or plastic film should also be kept away from the appliance, as they may fuse to the surface.
12. Never line the oven bottom with aluminium foil, as the consequent accumulation of heat could compromise the cooking and even damage the enamel.
13. **WARNING** - The oven will become hot during and directly after use. Do not touch any components during this time, as they may be hot and can cause burns. Do not touch the heating elements inside the oven to avoid burns. Children should be kept away. Use heat resistant cooking gloves where-ever possible when moving food and cooking utensils in and out of the oven.
14. Cleaning may only be commenced on the appliance once it has cooled down (best slightly warm). The appliance should be disconnected from the power outlet or turned off at your isolation switch before commencing any cleaning process. Do not use a steam jet or any other high-pressure cleaning equipment to clean the appliance. Follow oven cleaner directions if these are being used.
15. Wash all accessories in hot soapy water or in a dishwasher, wipe dry with a paper or cloth towel. If you use your oven for an extended period of time, condensation may form. Dry it using a soft dry cloth.
16. When the appliance is not being used, the knobs must be kept in the 'OFF' position.
17. Where this appliance is installed in a caravan, it shall NOT be used as a space heater.
18. Do not modify this appliance.
19. Do not use harsh abrasive cleaners or sharp metal scrapers to clean the oven door glass as it can scratch the surface, which may result in the glass shattering. Clean the glass door using warm damp cloth and dry it with a soft cloth.
20. All cabinetry and materials used in the installation must be able to withstand a minimum temperature of 50°C above the ambient temperature of the room it is located in, whilst in use. Certain types of vinyl or laminate kitchen furniture are particularly prone to heat damage or discolouration at temperatures outside the guidelines given above. Any damage caused by the appliance being installed without adhering to the temperature limits set out above will be the liability of the owner.
21. This appliance must be correctly installed by a suitably qualified person, strictly in accordance with the manufacturer's instructions. Please see the specific section of this booklet that refers to installation.
22. The appliance must be installed and put in operation by an authorised technician under the conditions provided by the manufacturer in this manual. The manufacturer cannot be held responsible for any damage that might occur due to faulty installation.
23. The values indicated on the printed documents found on the product are values obtained in laboratory environment according to relevant standards. These values may vary according to the usage and environment conditions of product.

Appliance Details

Electrical Details

Model	OBO696XB
Voltage Rating	220-240V ~50Hz
Power Rating	2400-2800W

Dimensions

LENGTH (mm)	WIDTH (mm)	HEIGHT (mm)
595	575	595

Electrical Connections



LOCAL AUTHORITY REQUIREMENTS

Installation is only permitted by a licensed electrician, and carried out according to instructions provided by the manufacturer. Incorrect installation might cause harm and damage which the manufacturer accepts no responsibility.

ELECTRICAL INSTALLATION FOR THE LICENSED ELECTRICIAN

This oven must be connected to a 220-240V 50Hz power supply. It is earthed via the cord. Before carrying out the connection to the power supply, the voltage rating of the appliance (stamped on the appliance identification plate) must be checked for correspondence to the available mains supply voltage, and the mains electric wiring should be suitable for the oven's power rating (also indicated on the appliance identification plate). A circuit breaker with a contact opening of at least 3 mm must be installed inside the supply circuit.

The switched outlet must be connected to a suitable earth wiring, in conformity to current safety regulations. It should not be located above the appliance and no more than 1.25m away from it. The power supply cord must not touch against any hot surfaces and must be placed so that its temperature does not exceed 75°C at any point along its length.

After having installed the appliance, the switched outlet must always be in an accessible position.

NOTE: For connections to the mains power supply, never use adapters, reductions or multiple power points as these may overheat and catch fire.

The mains terminal block is located on the back of the oven and the terminals are accessible by opening the terminal block cover. Note: The terminal cover should not be opened when the mains power is still connected to the appliance and never by an unauthorized person.

The electrical safety of this appliance can only be guaranteed if the oven is correctly and efficiently earthed. The manufacturer declines all responsibility for damage resulting from an installation which has not been earthed correctly.

The use of adapters, multiple sockets and/or extensions, is not allowed.

Installation Instructions



The adjacent furniture must be able to withstand a minimum temperature rise of 50°C above the ambient temperature of the room it is located in, during periods of use. The power supply to the appliance must be cut off before any adjustments or maintenance work is done on it.

Preparation for Installation and Use

WARNING: This appliance must be installed by an authorised service person or qualified technician, according to the instructions in this guide and in compliance with the current local regulations.

- Incorrect installation may cause harm and damage, for which the manufacturer accepts no responsibility and the warranty will not be valid.
- Prior to installation, ensure that the local distribution conditions (electricity voltage and frequency) and the adjustments
- of the appliance are compatible. The adjustment conditions for this appliance are stated on the label.
- The laws, ordinances, directives and standards in force in the country of use are to be followed (safety regulations, proper recycling in accordance with the regulations, etc.).

Instructions for the Installer

- After removing the packaging material from the appliance and its accessories, ensure that the appliance is not damaged. If you suspect any damage, do not use it and contact an authorised service person or qualified technician immediately.
- Make sure that there are no flammable or combustible materials in the close vicinity, such as curtains, oil, cloth etc. which may catch fire.
- The worktop and furniture surrounding the appliance must be made of materials resistant to temperatures above 50°C.
- The appliance should not be installed directly above a dishwasher, fridge, freezer, washing machine or clothes dryer.

Installation Instructions

The appliances are supplied with installation kits and can be installed in a worktop with the appropriate dimensions. The dimensions for hob and oven installation are given below.

A (mm)	557	min./max. F (mm)	560/580
B (mm)	550	min. G (mm)	555
C (mm)	595	min. H/I (mm)	600/590
D (mm)	575	min. J/K (mm)	5/10
E (mm)	574		

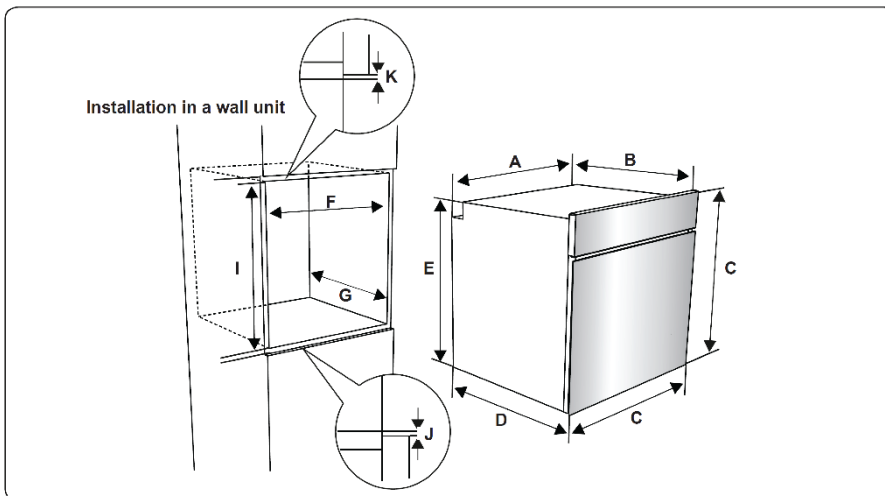
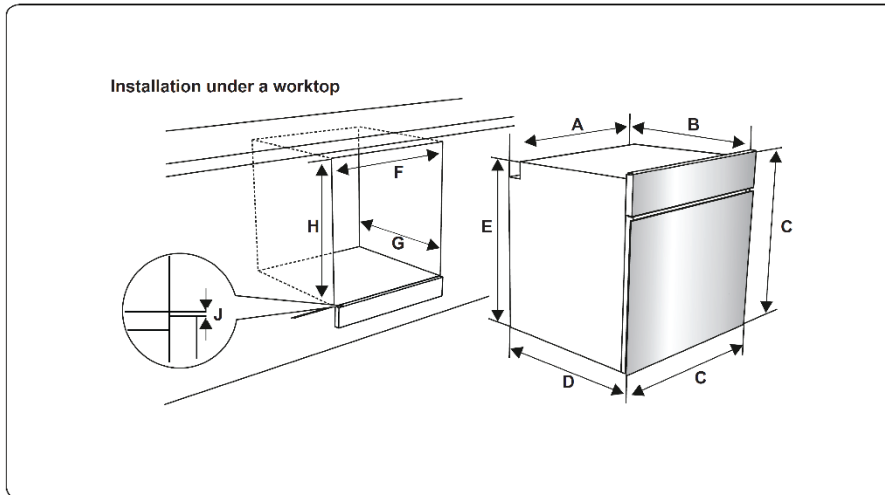

After making the electrical connections, insert the oven into the cabinet by pushing it forward. Open the oven door and insert 2 screws in the holes located on the oven frame. While the product frame touches the wooden surface of the cabinet, tighten the screws.

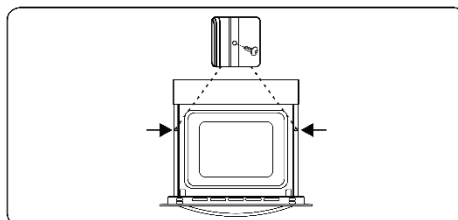

Installation Instructions

Electrical Connection and Safety



WARNING: The electrical connection of this appliance should be carried out by an authorised service person or qualified electrician, according to the instructions in this guide and in compliance with the current local regulations.

WARNING: THE APPLIANCE MUST BE EARTHED.

- Before connecting the appliance to the power supply, the voltage rating of the appliance (stamped on the appliance identification plate) must be checked for correspondence to the available mains supply voltage, and the mains electric wiring should be capable of handling the appliance's power rating (also indicated on the identification plate).
- During installation, please ensure that isolated cables are used. An incorrect connection could damage your appliance. If the mains cable is damaged and needs to be replaced this should be done by qualified personnel.
- Do not use adaptors, multiple sockets and/or extension leads.
- The supply cord should be kept away from hot parts of the appliance and must not be bent or compressed. Otherwise the cord may be damaged, causing a short circuit.
- If the appliance is not connected to the mains with a plug, an all-pole disconnecter (with at least 3 mm contact spacing) must be used in order to meet the safety regulations.
- The appliance is designed for a power supply of 220-240V ~ and 380-415V 3N~. If your supply is different, contact the authorised service person or a qualified electrician.
- The power cable (H05VV-F) must be long enough to be connected to the appliance, even if the appliance stands on the front of its cabinet.
- Ensure all connections are adequately tightened.

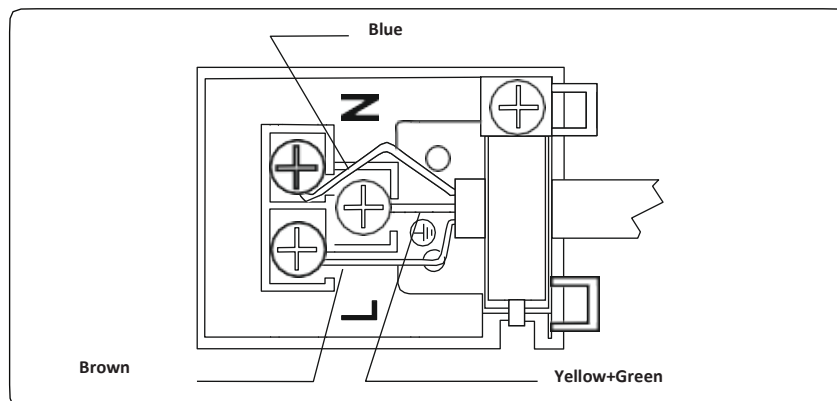

Operating Instructions

Internal View

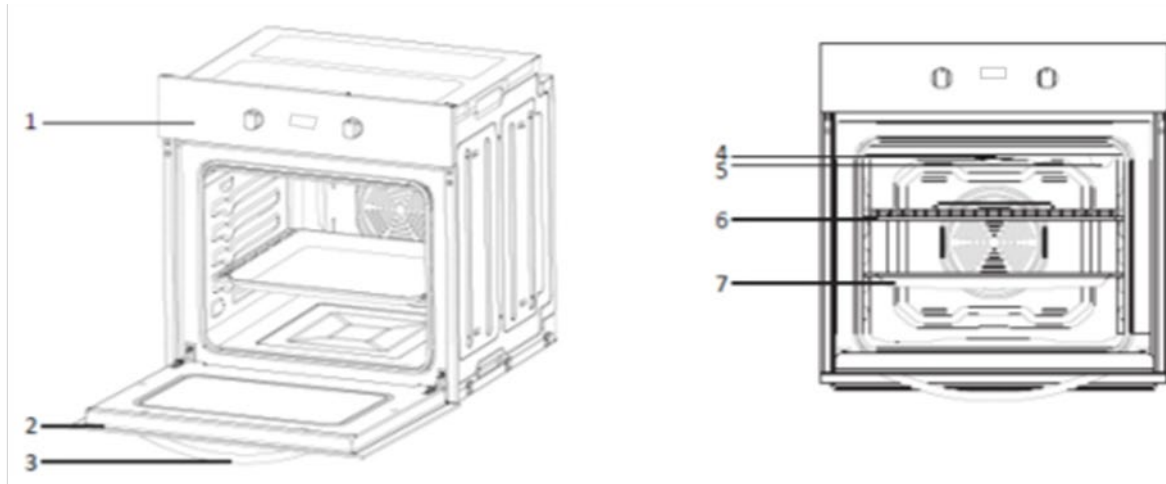

1. Control Panel
2. Oven Door
3. Handle
4. Grill Element

5. Oven Lamp
6. Wire Grill
7. Shallow Tray with grill insert
8. 80mm Deep Tray

When you first run your oven, a certain smell will emanate arising from the insulation materials and the heater elements. For this reason, before using your oven, run it empty at maximum temperature for 45 minutes. At the same time, you need to properly ventilate the environment in which the oven is installed. In order to cook in your oven, the oven function and temperature setting controls need to be adjusted and the oven timer, if available, needs to be programmed. Otherwise, the oven will not operate.

Unplug your appliance when it is not in use.

Protect your appliance from atmospheric effects. Do not leave it under the effects of the sun, rain, snow, dust etc.

Operating Instructions

Controls



Oven Function Control Knob

Digital Timer

Oven Thermostat Control Knob

OVEN FUNCTION CONTROL

The oven function control knob is used to select the different functions. Each is explained in detail. To select a function, turn the control knob to the desired oven function and then set the temperature with the thermostat control.

OVEN THERMOSTAT CONTROL

The oven thermostat control knob is used to select the desired temperature for cooking. When the temperature inside your oven reaches the value set, the thermostat will cut the circuit and the thermostat light will go off. When the temperature falls below the set value, the thermostat will again be turned on alongside the thermostat light. It is normal for this to occur during the cooking process, particularly when the door has been opened.



Function Selector

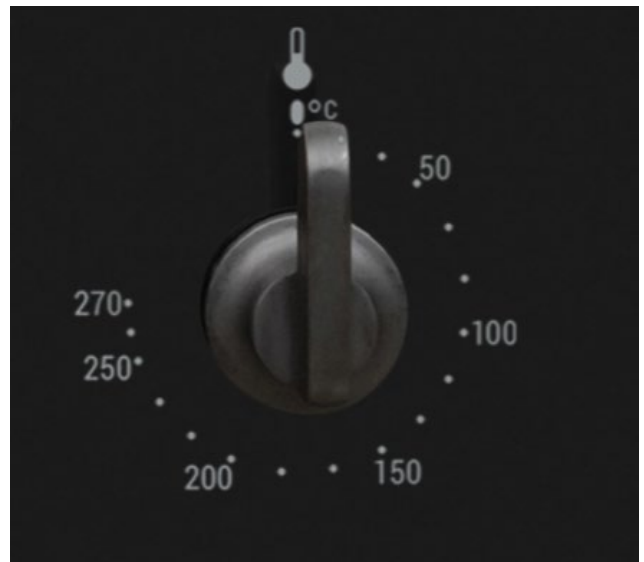

Thermostat Control

Operating Instructions

During heated oven functions a cooling fan in the top of the oven will operate in order to cool down the oven door and kitchen cabinet as well as reducing condensation in the oven. There will then be a slight release of warm air from the top of the closed oven door. This is not a leak in heat from the oven cavity.

Oven Functions

Defrost Function



You can start the defrost operation by putting the frozen food into oven and bringing the function control knob to the indicated mark. This function will not cook/bake the food; it only helps to defrost it within a short time.

Put the food to be defrosted on the wire rack that you will place on the middle rack support from the bottom (Figure 13). To collect the water that accumulates due to the melting ice, insert an oven tray onto a lower rack. This function is perfect for finishing off the defrost process for frozen food that has been in the refrigerator from the evening before and may not be completely thawed out.

Fan Forced Function



This Fan Forced function uses the turbo heater (located in the back of the oven) to evenly disperse the heat in the oven. This function is suitable for cooking multiple dishes on various oven shelves. Adjust the function control knob so it indicates the Fan Forced function symbol. Adjust the thermostat control knob of your oven to a temperature recommended on the cooking table for the cooking operation you wish to perform.

Preheating of the oven for about 10 minutes is recommended. Place the food in a suitable container, then place into oven and cook for the required time.

If you are going to cook using two trays at the same time, while adjusting the cooking temperature, select the temperature that is the lowest among the levels suitable for your food of choice, as shown on the table.

Cooking with two trays requires additional cooking time compared to cooking with one tray. Usually, the food on each tray does not finish at the same time so you may need to take the tray of cooked food out of the oven, and continue the cooking operation for the remaining tray.

After cooking, turn off the oven function and temperature control knobs and cancel the timer program if in use. Take the cooked food out of the oven and place it in a safe heatproof surface. As the oven will be hot, work near with caution and keep children away from the cooling oven.

Operating Instructions

Oven Functions

Conventional Cooking Function



This function, Conventional Cooking, allows heat to radiate evenly from the lower and upper elements into the oven ensuring even cooking of both sides of the food. Adjust the function control so it indicates the Conventional Cooking function symbol. Adjust the thermostat control knob of your oven to a temperature recommended on the cooking table for the cooking operation you wish to perform. Preheating of the oven for about 10 minutes is recommended. Place food in a suitable container, then place into oven and cook for the recommended time. This function is preferred for making cakes (cupcakes, other cakes and sponges), biscuits, pastry, baked pasta (e.g. lasagne), casseroles and moist dishes, roasts and oven chips.

After cooking, turn off the oven function and temperature control knobs and cancel the timer program if in use. Take the cooked food out of the oven and place it on a safe heatproof surface. As the oven will be hot, work with caution and keep children away from the cooling oven.

Fan Assist Function



This is the function where the air coming from the lower and upper heating elements is circulated into the oven by the fan motor and blade

Adjust the function control knob so it indicates the Fan Assist Function symbol and adjust the oven timer to the recommended time for cooking. Adjust the thermostat control knob to the temperature required on the cooking table for the Fan Assist Function and preheat oven for 10 minutes. Based on the conventional cooking function, this combination of features increases the effectiveness of the thermal radiation of the heating elements through forced air circulation of the heat throughout the oven. This helps prevent food from burning on the surface, allowing the heat to penetrate into the food. Food baked on this function such as pastry often brown faster than on convection function alone.

After cooking, turn off the oven function and temperature control knobs and cancel the timer program if in use. Take the cooked food out of the oven and place it on a safe heatproof surface. As the oven will be hot, work with caution and keep children away from the cooling oven.

Grill Function



This function is used for grilling. Adjust the function control knob so it indicates the Mid-Grill function symbol and adjust the oven timer to the recommended time for cooking. Set the oven's thermostat control knob to the required temperature. After a preheating period of 10 minutes, put your food into the oven. For grilling, put the food on the grill rack and sit into the tray. Place the tray on one of the highest shelves. Placing the rack within the oven tray provided will ensure that any marinade, fat or oil dropping from the food will be collected. When grilling, the oven door must be closed. On this function, the middle heating elements/coils of the grill operate.

This setting is ideal for toasting bread, cheese melts and melting cheese topped dishes or finishing off a dish to lightly brown on the surface. Also used for herb and garlic bread.

After cooking, turn off the oven function and temperature control knobs and cancel the timer program if in use. Take the cooked food out of the oven and place it in a safe heatproof surface. As the oven will be hot, work near with caution and keep children away from the cooling oven.

Operating Instructions

Oven Functions

Maxi-Grill Function



This function is used for faster grilling and for grills with a lot of food. Adjust the function control knob so it indicates the Maxi-Grill function symbol. Set the oven's thermostat control knob to the required temperature. After a preheating period of 10 minutes, put your food into the oven. For grilling, put the food on the grill rack and sit into the tray. Place the tray on one of the highest shelves. Placing the rack within the oven tray provided will ensure that any marinade, fat or oil dropping from the food will be collected. When grilling, the oven door must be closed. On this function, all of the heating elements/coils of the grill operate.

The higher grill temperature and function is ideal for cooking and browning meat (such as lamb or pork chops and cutlets), chicken and seafood (such as fish fillets, cutlets, tuna steaks or Atlantic salmon). This setting is also good for browning fruit crumbles or crumb topped dishes.

After cooking, turn off the oven function and temperature control knobs and cancel the timer program if in use. Take the cooked food out of the oven and place it on a safe heatproof surface. As the oven will be hot, work with caution and keep children away from the cooling oven.



ENERGY SAVING

Choose cookware of an appropriate size. Using a lid will reduce cooking times.

Minimize the amount of liquid or fat to reduce cooking times.

Oven door should not be opened often during cooking period.

Operating Instructions

Function Description	
A	Auto cooking
	Manual cooking
	Key Lock
	Minute minder
Mode	Mode function
-	Decrease timer
+	Increase timer
23:59	Timer display



Time Adjustment

The time must be set before you start using the oven. When the oven is first connected to the power supply, the symbol “A” and “00:00” or “12:00” will flash on the display.

1. Press the “**MODE**” button for 2 seconds to deactivate keylock. The dot in the middle of the screen will start to flash.
2. Adjust the time while the dot is flashing using the “+” and “-” keys.
3. Once the time is set, do not press any buttons and after a few seconds the dot will stop flashing and the time will be saved.



Key Lock



The key lock automatically activates after the timer has not been used for 7 seconds. The “” symbol will appear and remain illuminated. To unlock the timer buttons, press and hold the “**MODE**” button for 2 seconds. The desired operation can then be carried out.

Audible Warning Time Adjustment

The audible warning time can be set to any time between “00:00” and “23:59” hours.

The audible warning time is for warning purposes only. The oven will not be activated with this function.

1. Press “**MODE**”. The “” symbol will begin to flash and “00:00” will be displayed.
2. Select the desired time period using the “+” and “-” keys while “” is flashing.
3. The symbol “” will remain illuminated, the time will be saved and the warning will be set.

When the timer reaches zero, an audible warning will sound and the symbol “” will flash on the display. Press any key to stop the audible warning. Press “**MODE**” for 2 seconds. The “” symbol will disappear and the clock will be displayed.

Operating Instructions

Semi-automatic Time Adjustment (Cooking Period)

This function helps you to cook for a fixed period of time. A time range between 0 and 10 hours can be set. Prepare the food for cooking and put it in the oven.

1. Select the desired cooking function and the temperature using the control knobs.
2. Press **“MODE”** until you see **“dur”** symbol on the display screen. The symbol **“A”** will flash.
3. Select the desired cooking time period using the **“+”** and **“-”** keys.
4. The current time will reappear on the screen, and the symbols **“A”** and **“☞”** will remain illuminated.

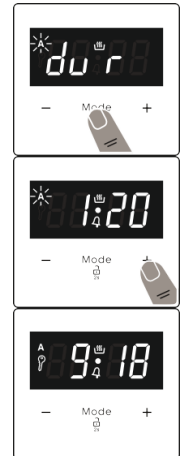

When the timer reaches zero, the oven will switch off and an audible warning will sound. The symbol **“A”** will flash. Turn both control knobs to the **“0”** position and press any key on the timer to stop the warning sound. Press **“MODE”** for 2 seconds and the **“A”** symbol will disappear and the timer will switch back to manual function.

Semi-automatic Time Adjustment (Finishing Time)

This function automatically starts the oven so that cooking will finish at a set time. You can set an end time of up to 10 hours after the current time of day. Prepare the food for cooking and put it in the oven.

1. Select the desired cooking function and the temperature using the control knobs.
2. Press **“MODE”** until you see **“end”** symbol on the display screen. **“A”** and the current time of day will flash.
3. Use the **“+”** and **“-”** buttons to set the desired finishing time.
4. The current time will reappear on the screen, the symbols **“A”** and **“☞”** will remain illuminated.



When the timer reaches zero, the oven will switch off and an audible warning will sound. The symbol **“A”** will flash. Turn both control knobs to the **“0”** position and press any key on the timer to stop the sound. Press **“MODE”** for 2 seconds and the **“A”** symbol will disappear and the timer will switch back to manual function.

Operating Instructions

Full-automatic Programming

This function is used to start cooking after a certain period of time and for a certain duration. A time of up to 23 hours and 59 minutes after the current time of day can be set. Prepare the food for cooking and put it in the oven.

1. Select the desired cooking function and the temperature using the control knobs.
2. Press **“MODE”** until you see **“dur”** symbol on the screen. The symbol **“A”** will flash.
3. Select the desired cooking time period using the **“+”** and **“-”** keys.
4. Press **“MODE”** until you see **“end”** symbol on the screen. The time and the symbols **“A”** will flash.
5. Select the desired finishing time using the **“+”** and **“-”** keys. **“☞”** symbol will disappear. Add the cooking period to the current time of day. You can set a time of up to 23 hours and 59 minutes after this.
6. The current time will reappear on the screen, and the symbols **“A”**, and will remain illuminated.

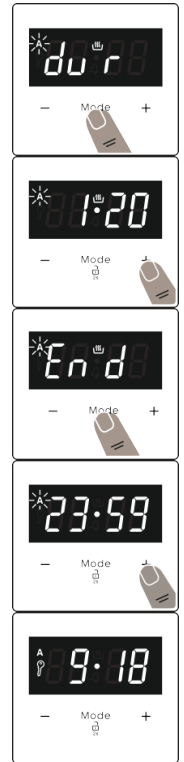

The operating time will be calculated and the oven will automatically start. The **“☞”** symbol will reappear on the screen so that cooking will finish at the set finishing time. When the timer reaches zero, the oven will switch off, an audible warning will sound and the symbol **“A”** will flash. Turn both control knobs to the **“0”** position and press any key to stop the sound. The symbol will disappear and the timer will switch back to manual function. Press **“MODE”** for 2 seconds and the **“A”** symbol will disappear and the timer will switch back to manual function.

Sound Adjustment

To adjust the volume of the audible warning sound, while the current time of day is displayed, press **“+”** and **“-”** keys and the dot in the middle of the screen will start to flash. Press **“MODE”** to display current signal sound. After this, each time the **“-”** button is pressed, a different signal will sound. There are three different types of signal sounds. Select the desired sound and do not press any other buttons. After a short time, the selected sound will be saved.

Accessories

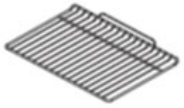

Wire Grid

The wire grid is used to grill or to place different cookware on it. To place the wire grid correctly in the cavity, put it on any rack and push it back to the end.



Deep Tray

The deep tray is used to cook stews. To place the deep tray correctly in the cavity, put it on any rack and push it back to the end.

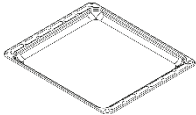

The Shallow Tray

The shallow tray is best used for baking pastries. Put the tray into any rack and push it to the end to make sure it is correctly placed.

You can use glass containers, cake pans and special oven trays suitable for use in your oven (available in kitchenware shops). Pay attention to the information given by the supplier for use of this cookware. The information given below should be implemented for enameled containers.

If the food to be cooked does not completely cover the oven tray, if the food is taken out of the deep-freezer or if the tray is used to collect the dripping juices of the foods during the grill operation, deformation might be observed on the tray over time due to high temperatures forming during the cooking/baking operation. This is a normal, physical state that results during the heat transfer. Do not leave a glass tray or container in a cold environment immediately after cooking in them. Do not place them on cold and wet surfaces. Ensure that they slowly cool off by placing them on a dry piece of cloth or wooden board, otherwise, the glass tray or container might break. If you are going to use the large wire oven rack/grill, insert a tray into one of the lower racks to collect fat or oil. To make cleaning easier, add some water into this tray. In a grilling operation, use the shelf in one of the top positions.

Each wire grid comes with a built-in safety feature to help minimise them being accidentally pulled fully out. This comes in the way of a "step", positioned part-way in from the rear of the accessory.

To fit them into the oven, push the wire grid or tray part way into the oven until the step "catches", then angle the part over the step & fully insert. To remove, repeat the operation in reverse.

EasyFix Wire Rack

Clean the accessories thoroughly with warm water, detergent and a soft clean cloth on first use.

Insert the accessory to the correct position inside the oven.

- Allow at least a 1 cm space between the fan cover and accessories.
- Take care removing cookware and/or accessories out of the oven. Hot meals or accessories can cause burns.
- The accessories may deform while with heat. Once they have cooled down, they will recover their original appearance and performance.
- Trays and wire grids can be positioned on any level from 1 to 8.
- Telescopic rails can be positioned on levels T1, T2, T3, 4, 5, 6, 7, 8.
- Level 3 is recommended for single level cooking.
- Level T2 is recommended for single level cooking with telescopic rails.
- Level 2 and Level 4 are recommended for double level cooking.
- Level T1 and Level T3 are recommended for double level cooking with telescopic rails.

****Accessories may vary depending on the model purchased.

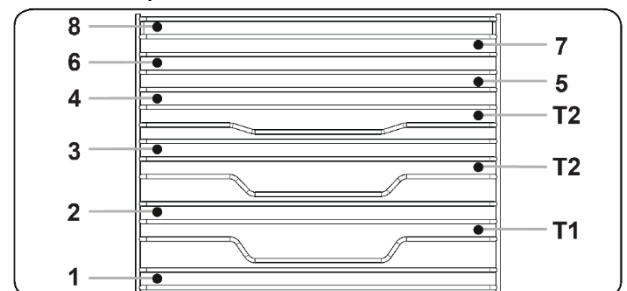

Replacing the Oven Lamp

- The appliance must first be disconnected from the power outlet or turned off at your isolation switch.
- Unscrew the glass cover attached to the lamp holder; anti-clockwise.
- Unscrew the lamp and replace it with another high-temperature lamp with the following characteristics:

Type	E14
Voltage Rating	220-240V
Power Rating	25W
Temperature Rating	300°

- Remount the glass cover and reconnect the appliance to the power supply

NOTE: Should you experience any difficulty please contact your nearest after-sales service centre.

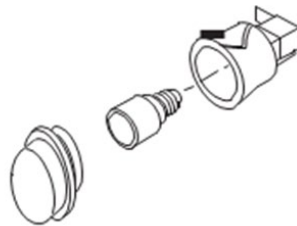

Cleaning



NOTE: Cleaning and maintenance operations must only be carried out when the oven is cool. The appliance should be disconnected from the power outlet or turned off at your isolation switch before commencing any cleaning process.

Cleaning the oven exterior

Before starting to clean your oven, be sure that all control buttons are off and your appliance has cooled off. Unplug the appliance.

Do not use cleaning materials containing particles that might scratch the enamelled and painted parts of your oven. Use cream cleaners or liquid cleaners, which do not contain particles. As these cleaners may damage the surfaces, do not use caustic creams, abrasive cleaning powders, rough wire wool or hard tools. In the event of any excess liquids spilling over your oven surface during cleaning, clean up immediately so as to prevent possible damage to the enamel or metal surface. Do not use steam cleaners for cleaning the oven.

Cleaning the interior of the oven

Make sure to unplug the oven before starting to clean it. You will obtain best results if you clean the oven interior while the oven is slightly warm (the oven should not be operating). Remove the internal wire shelves by unclipping them from the sides (these can be washed in soapy water but do not use a dishwasher). Wipe your oven with a soft piece of cloth (e.g. dish cloth) dampened with warm soapy water after each use, rinse cloth in warm water then wipe oven again and then finish by wiping with a dry cloth. For a complete cleaning process, use dry and powder type oven cleaners, following the oven cleaning product's instructions. Re-fit the wire shelves.

Troubleshooting

If the oven does not operate:

- The oven may be unplugged from the power source or switched off at the power source.
- The household fuse has blown or household power supply is off.
- The Timer (if available) may not set correctly.

If the oven does not heat:

- The heat may not be set correctly with the oven's temperature setting.

If the interior lighting lamp does not light:

- The lamps are defective. If they are defective, you can change them following the instructions within this manual.

Cooking (if lower-upper part does not cook equally):

- Control the shelf locations, cooking period and heat values according to the manual.

Unit smoking when first used:

- This is a result of protective oils being removed and is to be expected with a first use.

Oven fan is still running even though knobs in off position:

- The cooling fan has activated to cool down the control, this is normal and may stay on for some time.

Clock Flashing on Display

- Power failure or interruption

If you have any further problems with your product, please call your Authorised Service Centre.

Australian & New Zealand Product Warranty Statements of Standard Warranty Conditions

Australian Customers

Our goods come with guarantees that cannot be excluded under the Australian Consumer Law. You are entitled to a replacement or refund for a major failure and for compensation for any other reasonably foreseeable loss or damage. You are also entitled to have the goods repaired or replaced if the goods fail to be of acceptable quality and the failure does not amount to a major failure.

New Zealand Customers

Nothing herein contained shall be construed in any way as excluding or limiting your rights under the Consumer Guarantee Act 1993.

Our Warranty

This product is also covered by the manufacturer's warranty set out in this document (Our Warranty).

Our Warranty is for a period of twenty-four (24) months from the date of purchase and for refrigeration appliances will have an additional thirty-six (36) months after the first twenty-four (24) months on the Sealed System (PARTS only) Compressor & condenser etc. The labour cost to replace these parts is the responsibility of the customer. This is in addition to (and does not exclude, restrict or modify) any rights or remedies to which you may already be entitled under the Australian Consumer Law or the New Zealand Consumer Guarantee Act 1993 relating to this product. Our Warranty (which is subject to the conditions below) covers rectification free of charge of any fault arising from defective materials or components, or faulty workmanship. The product will be repaired or replaced at the option of Omega, and all costs of installation, removal, cartage, freight travelling expenses and insurance are to be paid by the customer. Our Warranty is subject to the following conditions:

1. That the purchaser contact Omega prior to any product repair.
2. That the purchaser carefully follows all instructions provided with the product and complies with all relevant electrical & plumbing regulations in their State when installing the product.
3. That the purchaser carefully follows the instructions provided in the owner's handbook relating to the proper use and care of the product and does not use the product for any purpose other than the DOMESTIC use for which it has been designed. If the appliance is used in commercial applications or for rental purposes, Our Warranty is limited to a warranty of Twelve (12) months covering all parts with Three (3) months on any labour cost of service or repair.

Service Area

The provision of service under Our Warranty is limited by the boundary / territory area of the nearest service centre. Travelling cost incurred for service outside this area is not covered by Our Warranty

and service will incur commercial cost to be paid by the customer regulated by the number of kilometres travelled beyond the service area. These costs will be disclosed to you for acceptance by you prior to your claim being processed. Microwave ovens must be returned to your nearest Authorised Service Centre for repair as they are a carry in serviceable appliance.

What is Covered by our Warranty

During the warranty period, Omega or its authorised Service Centre will, at no extra charge, if your appliance is readily accessible without the need of special equipment and subject to the terms and conditions of this warranty, repair or replace any parts which it considers defective.

What is not Covered by our Warranty

1. Products installed damaged or incomplete or not in compliance with the relevant electrical & plumbing regulations in their State.
2. Normal wear and tear e.g. cleaning, light globes, filters etc.
3. Failure resulting from power surges and electrical storms.
4. Insect or vermin infestation.
5. Unauthorised repairs or use of non-genuine Omega parts.
6. Any failure caused by the product not being used in accordance with the instruction and the installation manual provided with the product.
7. Misuse or abuse, including failure to properly maintain or service.
8. The clearing of blockages in pumps and hoses.
9. Damage which occurs during delivery or installation.
10. Claims to product surface coating due to liquid or solid spill-overs, accidental damage or damage caused from cleaning products not recommended by Omega.

How to Claim Our Warranty

While registering your warranty is not a requirement, for peace of mind you can register your warranty at omegaappliances.com.au.

To make a claim under Warranty you will need to contact Omega in Australia or New Zealand by using the contact details below.

If you are contacting Omega regarding any warranty claims and spare parts inquiries, please make sure you have the following information on hand:

1. Product Name/Model Number
2. Serial Number/s
3. Purchase Date (as per invoice or proof of purchase)
4. Purchased From
5. Warranty Registration Number (if registered)

Contact Us Australia

Omega is a division of Shiro Australia Pty Ltd
Phone: 1300 739 033
Email: customercare@omegaappliances.com.au

Contact Us New Zealand

Omega is a division of Monaco Corporation (member of Shiro)
Phone: 09 415 6000
Email: customercare@monacocorp.co.nz



52327841

omega

omegaappliances.com.au
omegaappliances.co.nz

 omegaappliances
 @omegaappliances_au

Email: customercare@omegaappliances.com.au
Phone: 1300 739 033